

Introduction

- Read this manual before installation and connection. Read the "Setting Manual" and "Operation Manual". The manuals can be downloaded from our homepage at "https://www.aiphone.net/product/support/" free of charge. (The manuals will be available from 9 November 2018 onwards.)
- After completing installation and connection, program the system according to the "Setting Manual". The system cannot operate unless it is programmed.
- After performing installation, review with the customer how to operate system. Leave documentation accompanying the Master Station with the customer.

! Perform installation and connection only after gaining sufficient understanding of the system and this manual. The illustrations used in this manual may differ from the actual stations.

Example of System Configuration

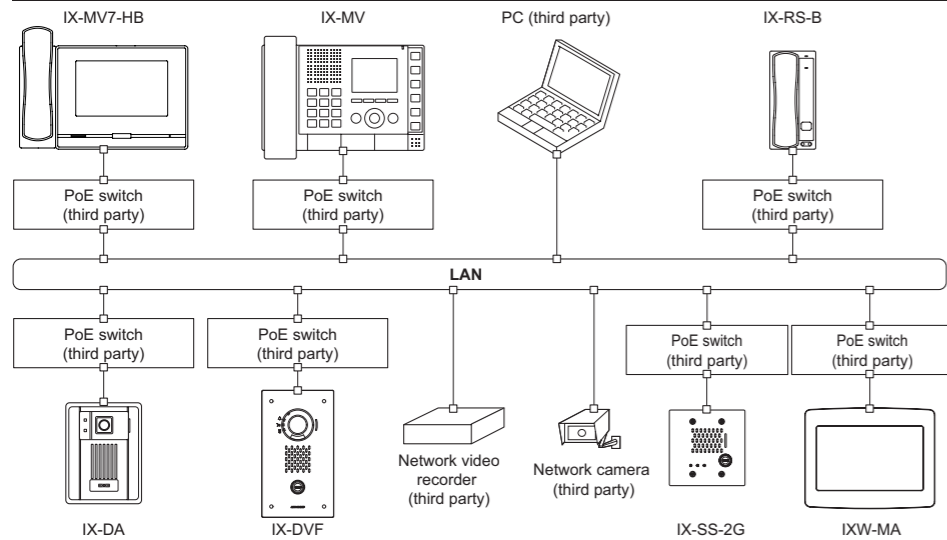

Status Indicator

Refer to "IX-RS-W, IX-RS-B Operation Manual" for additional indicators not listed below.

| Status (pattern) | | Meaning |
|------------------|---|-----------------------------|
| Orange flashing | Normal flashing → [Lit 0.75 sec] → [Off 0.75 sec] | Booting |
| | Rapid flashing → [Lit 0.25 sec] → [Off 0.25 sec] | Device error, Startup error |
| | Long interval flashing → [Lit 0.5 sec] → [Off 4 sec] | Communication failure |
| | Long irregular flashing → [Lit 1 sec] → [Off 0.25 sec] → [Lit 0.25 sec] → [Off 0.25 sec] → [Lit 0.25 sec] → [Off 0.25 sec] | Firmware version updating |
| | Short irregular flashing → [Lit 1 sec] → [Off 0.25 sec] → [Lit 0.25 sec] → [Off 0.25 sec] | Initializing |
| Blue light | [Lit] | Standby |

Part Names and Accessories

IX-RS-B, IX-RS-W

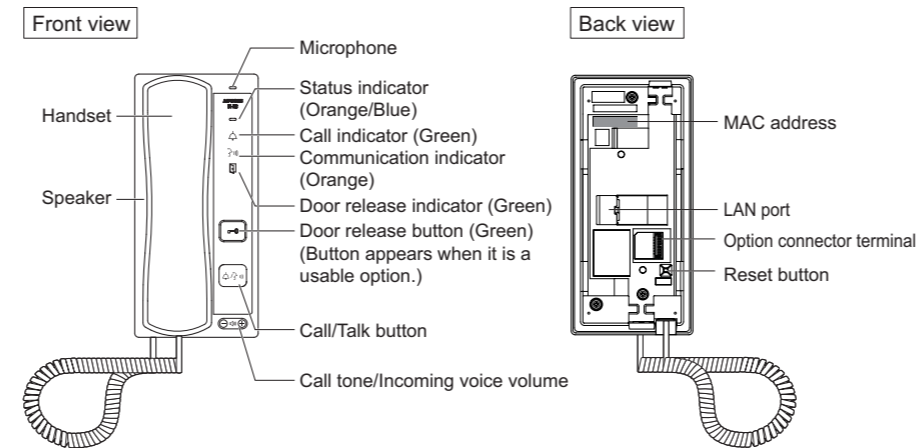

Included accessories

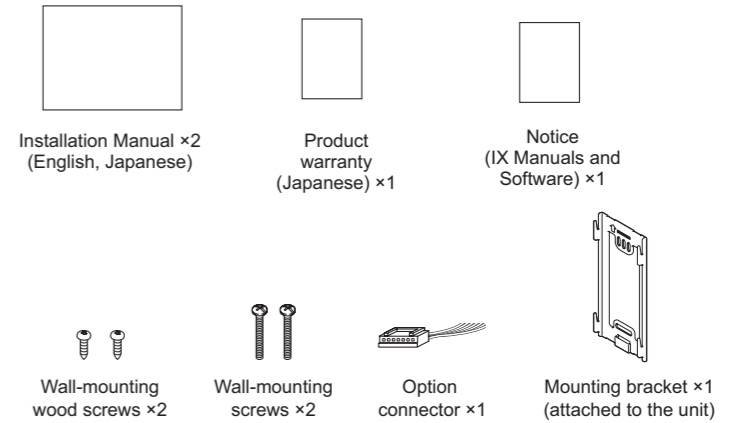

Precautions

Warning Negligence could result in death or serious injury.

- Do not disassemble or modify the device.** May cause fire or electrical shock.
- Do not, under any circumstances, open up the device.** Voltage within some internal components may cause electrical shock.
- The device is not designed to explosion-proof specifications. Do not install or use in an oxygen room or other such locations filled with volatile gases.** May cause fire or explosion.

General Precautions

- Install low-voltage lines at least 30cm (11") away from high-voltage lines (AC100V, 200V), especially inverter air conditioner wiring. Failure to do so may result in interference or malfunction.

Notice

- The illustrations and images used in this manual may differ from the actual items.
- If the device is used in areas where there are business-use wireless devices such as a transceiver or mobile phones, it may cause malfunction.
- If the device is installed close to a light dimmer, an inverter electrical appliance or the remote control unit of a hot-water system or floor-heating system, it may create interference and cause a malfunction.
- If the device is installed in an area with an extremely strong electrical field, such as in the vicinity of a broadcasting station, it may create interference and cause a malfunction.

Caution Negligence could result in injury to people or damage to property.

- Do not install or connect the device with the power on.** May cause electrical shock or malfunction.
- Do not turn on power without first checking to make sure the wiring is correct and there are no improperly terminated wires.** May cause fire or electrical shock.
- Install the device in a position where it will not easily be brushed against by somebody's shoulder, etc.** Failure to do so could result in injury.
- For testing and verification of chime volume and call tone volume, do not hold the handset close to your ear.** May cause harm to the ear if a sudden loud noise is emitted.
- Do not put your ear close to the speaker when using the device.** May cause harm to the ear if a sudden loud noise is emitted.

Precautions for mounting

- Installing the device in the following locations could cause malfunction:
 - Locations exposed to direct sunlight**
 - Locations that get hot**
Close to a heater, boiler, etc.
 - Locations where there is risk of exposure to liquid, dust, oil, or chemicals**
 - Locations with high humidity**
Bathroom, basement, greenhouse, etc.
 - Locations with low temperature**
Inside a cold storage warehouse, the front of a cooler, etc.
 - Locations directly exposed to steam or oil smoke**
Next to heating devices or a cooking space, etc.
 - Sulphurous environments such as a hot spring area**
 - Locations close to the sea or directly exposed to sea breeze**
- If existing wiring is used, the device may not operate properly. In that case, it will be necessary to replace the wiring.
- Do not, under any circumstances, use an impact driver to fasten screws. Doing so may cause damage to the device.

How to Install

Installation of Handset Sub Station

Back wiring

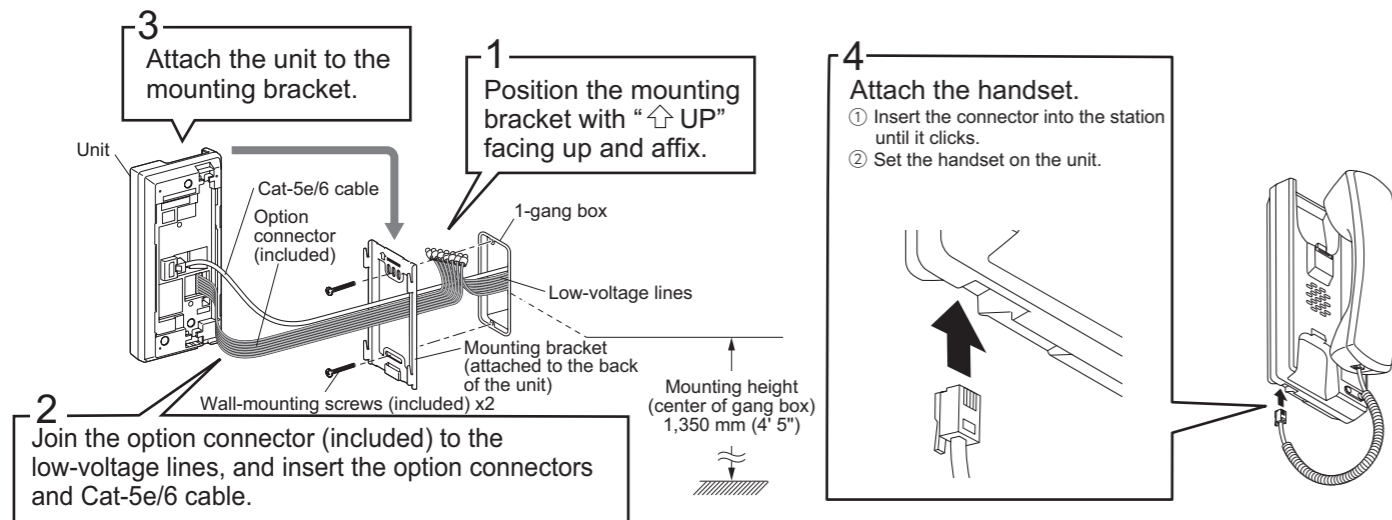

Surface wiring

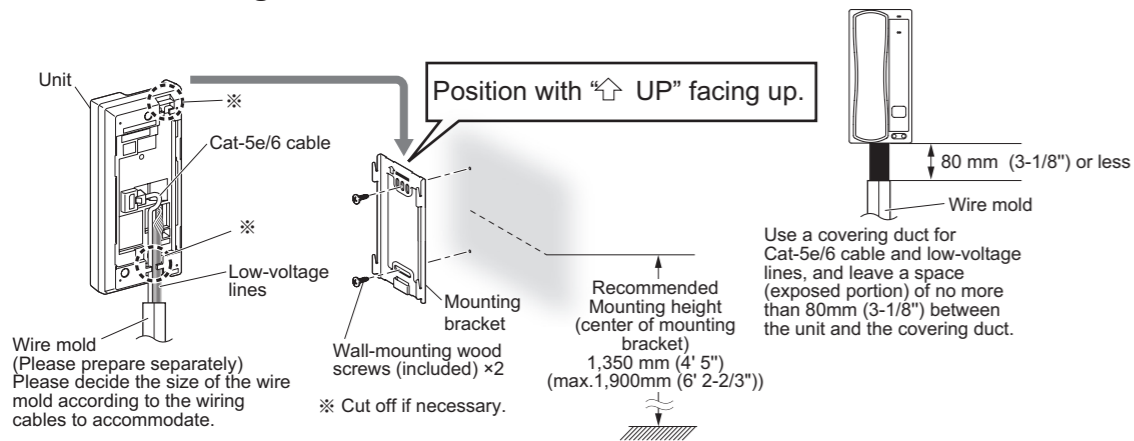

How to Connect

Connection Precautions

Cat-5e/6 cable

- For connection between devices, use a straight-through cable.
- If necessary, when bending the cable, please observe the manufacturer's recommendations. Failure to do so could cause a communication failure.
- Do not strip away the cable insulation any more than is necessary.
- Perform termination in accordance with TIA/EIA-568A or 568B.
- Before connecting the cable, be sure to verify conduction using a LAN checker or similar tool.
- A RJ45 covered connector cannot be connected to the LAN ports of the master stations or the door stations. Use cables without covers on the connectors.



- Be careful not to pull on the cable or subject it to excessive stress.

Precautions regarding low-voltage line

- Use PE (polyethylene)-insulated PVC jacketed cable. Parallel or jacketed conductors, mid-capacitance, non-shielded cable is recommended.
- Never use twisted-pair cable or coaxial cable.
- 2Pr quad V twisted pair cables cannot be used.

Parallel cable Coaxial cable



When connecting low-voltage lines, perform the connection using either the crimp sleeve method or soldering, then insulate the connection with electrical tape.

Crimp sleeve method

- Line up the solid wire and stranded wire and crimp them together.
- Overlap the tape by at least a half width and wrap the connection at least twice.

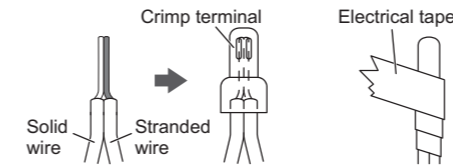

Soldering method

- Twist the stranded wire around the solid wire at least 3 times.
- After bending down the point, perform soldering, with care that no wires protrude from the soldering.
- Overlap the tape by at least a half width and wrap the connection at least twice.

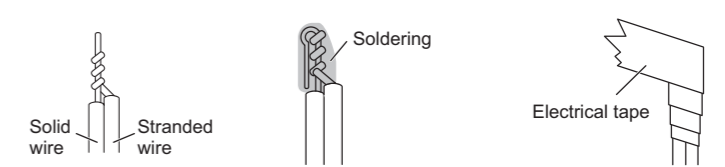

- If the connector-attached lead wire is too short, extend the lead with an intermediate connection.
- As the connector has polarity, perform the connection correctly. If the polarity is incorrect, the device will not operate.
- When using the crimp sleeve method, if the end of the connector-attached lead wire has been soldered, first cut off the soldered part and then perform crimp.
- After completing connection of wires, check that there are no breaks or inadequate connections. When connecting low-voltage lines in particular, perform the connection using either soldering or the crimp sleeve method and then insulate the connection with electrical tape. For optimal performance, keep the number of wiring connections to a minimum.**

Simply twisting low-voltage lines together will create poor contact or will lead to oxidization of the surface of the low-voltage lines over long-term use, causing poor contact and resulting in the device malfunctioning or failure.



Wiring Connection

- Insulate and secure unused low-voltage lines and the connector-attached lead wire.

Handset Sub Station

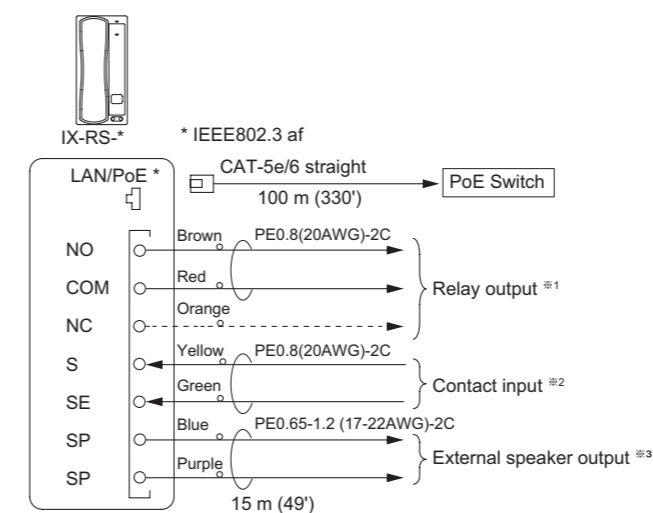

※ 1 Relay Output Specifications

| | |
|----------------|--|
| Output method | Form C dry contact (N/O or N/C) |
| Contact rating | 24 VAC, 1A (resistive load) 24 VDC, 1A (resistive load) Minimum overload (AC/DC): 100mV, 0.1mA |

※ 2 Option Input Specifications

| | |
|--------------------------------|--|
| Input method | Programmable dry contact (N/O or N/C) |
| Detection time | Level detection method 100 msec or more |
| Contact resistance | Make: 700 Ω or less Break: 3 kΩ or more |
| Terminal short-circuit current | 10 mA or less |
| Voltage between terminals | 5.5 VDC or less (between open terminals) |

※ 3 External Speaker Output Specifications

| | |
|----------------------|-----|
| Output impedance | 8 Ω |
| Maximum output power | 2 w |