

# AIPHONE

## JP-DA, JP-DV, JP-DVF

VIDEO DOOR STATION  
POSTE DE PORTE VIDÉO  
VIDEO PORTERO  
VIDEODEURPOST  
POSTAZIONE VIDEOCITOFONICA ESTERNA

---

INSTALLATION MANUAL  
MANUEL D'INSTALLATION  
MANUAL DE INSTALACIÓN  
INSTALLATIEHANDLEIDING  
MANUALE D'INSTALLAZIONE

---

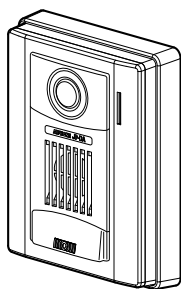

### JP-DA

*Video door station  
Poste de porte vidéo  
Video portero  
Videodeurpost met kunststof  
opbouwbehuizing  
Postazione videocitofonica  
esterna*

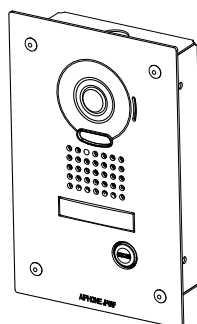

### JP-DVF

*Vandal-resistant video door station  
Portier vidéo résistant au vandalisme  
Video portero antivandálico  
Videodeurpost met inox antivandalisme-  
inbouwbehuizing  
Postazione videocitofonica esterna  
resistente agli atti vandalici*

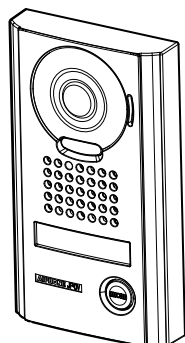

### JP-DV



*Vandal-resistant video door station  
Portier vidéo résistant au vandalisme  
Video portero antivandálico  
Videodeurpost met metalen  
antivandalisme-opbehuizing  
Postazione videocitofonica esterna  
resistente agli atti vandalici*

# PRECAUTIONS

-  General Prohibitions  
  Prohibition to Dismantle the Unit  
  Prohibition on Subjecting the Unit to Water  
  General Precautions



## WARNING

**Negligence could result in death or serious injury.**

-  1. Do not dismantle or alter the unit. Fire or electric shock could result.
-  2. Existing wiring such as chime wiring, etc. may contain high voltage AC electricity. Damage to the unit or electric shock could result. Wiring and installation should be done by a qualified technician.
-  3. This unit is not an explosion-proof unit. Do not install or use the unit in locations that are filled with flammable gas such as oxygen rooms. Fire or an explosion could result.

## CAUTION

**Negligence could result in injury to people or damage to property.**









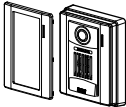
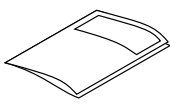

-  1. Before turning on power, make sure wires are not crossed or shorted. If not, fire or electric shock could result.
-  2. Do not install or make any wire terminations while power supply is plugged in. It can cause electrical shock or damage to the unit.

## GENERAL PRECAUTIONS

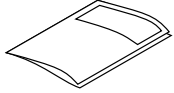
1. The door station is weather resistant, but do not spray high pressure water on door station directly. Unit trouble could result.

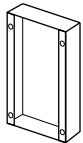
# PACKAGE CONTENTS

Verify that the following parts are included.

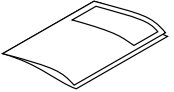
<b>JP-DA</b>	 Front panel Main unit		 Installation manual			
<b>JP-DV</b>	 The unit	 Special screwdriver	 Transparent nameplate (x2)	 Installation manual		
<b>JP-DVF</b>	 The unit	 Flush mount back box	 Special screw (x4)	 Hexagonal wrench	 Transparent nameplate (x2)	 Installation manual

# INSTALLATION

## Mounting locations

"Do not install video door station in any of the following locations where lighting or the ambient environment could impact the display on the video monitor due to the characteristics of the door station's camera."

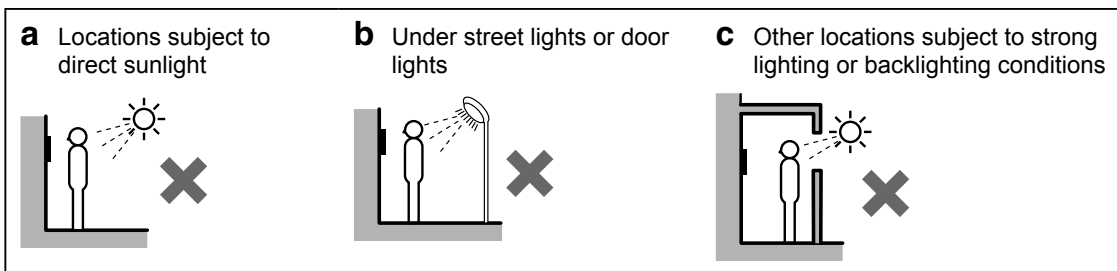

## Mounting positions and image view area

◇ Wide picture

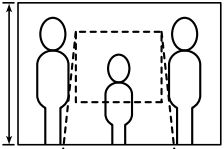

◆ Objects appear smaller due to greater distortion in the surrounding sections compared to the central section, but a wider area is displayed. The display range is a rough estimation and may change due to the installation environment.

◇ Zoom picture

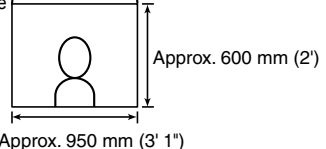

◆ The zoom position can be changed. (Refer to the master station's operation manual.) The factory setting is "Center" for Zoom mode.

◇ Wide picture

**Up/Down**

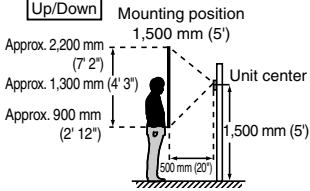
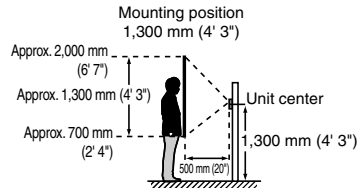
**Left/Right**

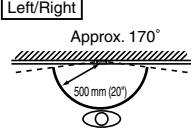

◆ An area over a range of approx. 170° in a 500 mm radius from the camera displays. (The display range is a rough estimation and may change due to the installation environment.)

---

◇ Zoom picture (when mounting position is 1,500 mm (5'))

**Up/Down**

Zoom <Up>: Approx. 2,250 mm (7' 5"), Approx. 750 mm (2' 5"), Approx. 1,500 mm (5'). Unit center 1,500 mm (5'). 500 mm (20").

Zoom <Center>: Approx. 1,850 mm (6' 1"), Approx. 600 mm (2'), Approx. 1,250 mm (4' 1"). Unit center 1,500 mm (5'). 500 mm (20").

Zoom <Down>: Approx. 1,550 mm (5' 1"), Approx. 750 mm (2' 5"), Approx. 800 mm (2' 8"). Unit center 1,500 mm (5'). 500 mm (20").

**Left/Right**

Zoom <Left>: Approx. 140°, Approx. 500 mm (20"), Approx. 950 mm (3' 1").

Zoom <Center>: Approx. 500 mm (20"), Approx. 950 mm (3' 1").

Zoom <Right>: Approx. 140°, Approx. 500 mm (20"), Approx. 950 mm (3' 1").

## Cable

- Use PE (polyethylene)-insulated PVC jacket cable. Parallel or jacketed 2-conductor, mid-capacitance, non-shielded cable is recommended.
- Never use individual conductors, twisted pair cable, or coaxial cable.

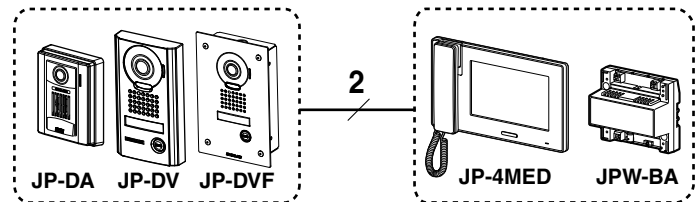

## Wiring distance

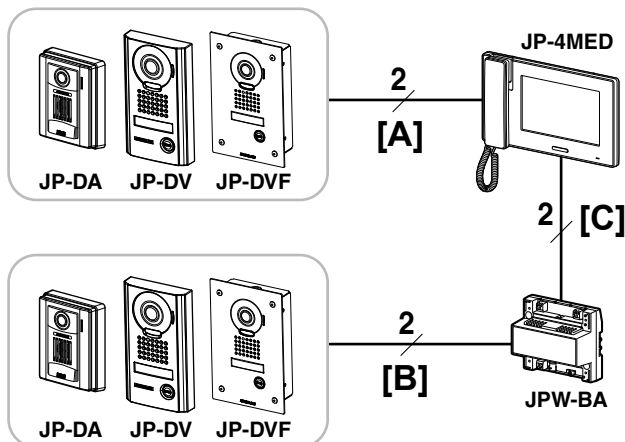

		Wire diameter			
		Ø0.65 mm (22 AWG)	Ø0.8 mm (20 AWG)	Ø1.0 mm (18 AWG)	Ø1.2 mm (16 AWG)
[A]	Door station - master station	50 m (165')	100 m (330')	100 m (330')	100 m (330')
[B]	Door station - long distance adaptor	100 m (330')	150 m (490')	200 m (650')	200 m (650')
[C]	Long distance adaptor - master station	50 m (165')	75 m (245')	100 m (330')	100 m (330')

# MOUNTING

## JP-DA

### ① Removing the main unit from the mounting frame

Remove the main unit. (Loosen the locking screws.)

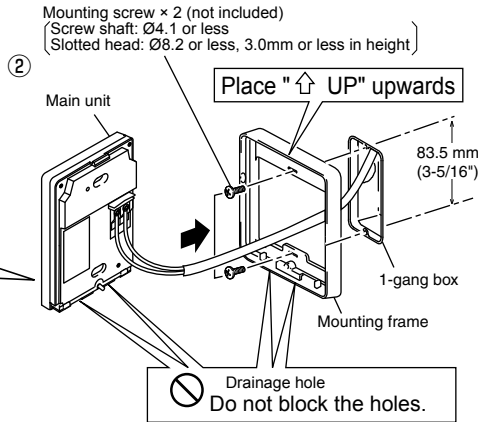
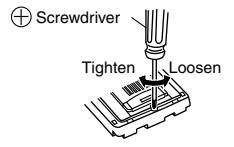

### ③ Mount the main unit on the mounting frame, and fit the front panel on.

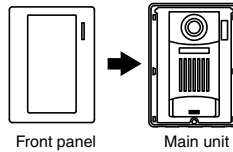

### Removing the front panel

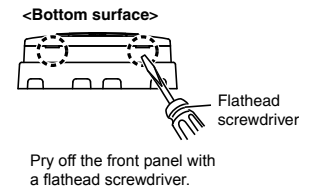

## JP-DV

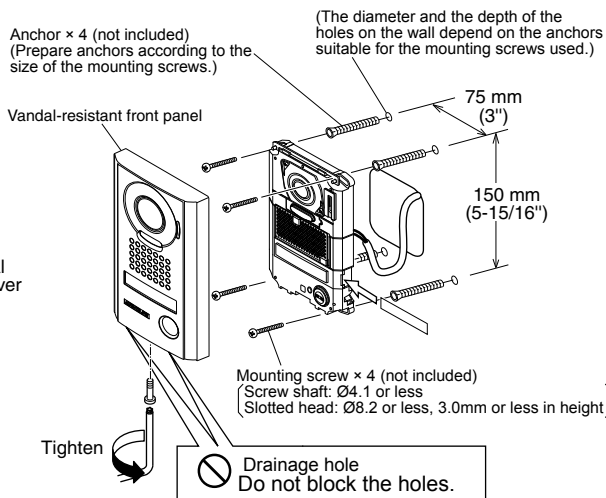
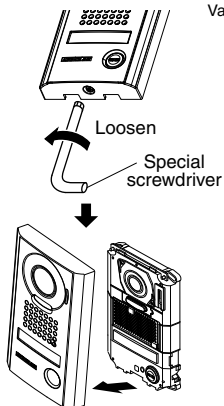

### Using the transparent nameplates

#### Inserting the transparent nameplates

- Remove the vandal-resistant front panel.
- Peel off the protective seals on the plate (both sides).
- Fill in the name of the resident on the transparent nameplate.
  - Be sure to leave 25 mm (1") of white space on the right end to account for insertion.
- Insert the filled-in transparent nameplate at the specified insertion opening (indicated with ← in diagram) as below.

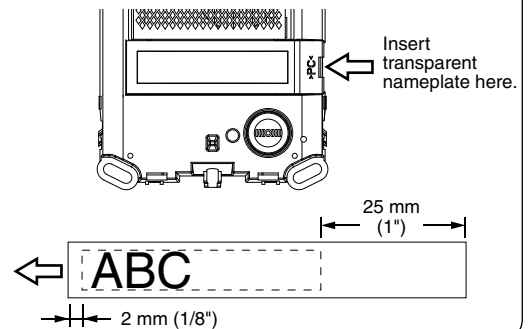

\* Remove protective film from camera before use.

## JP-DVF

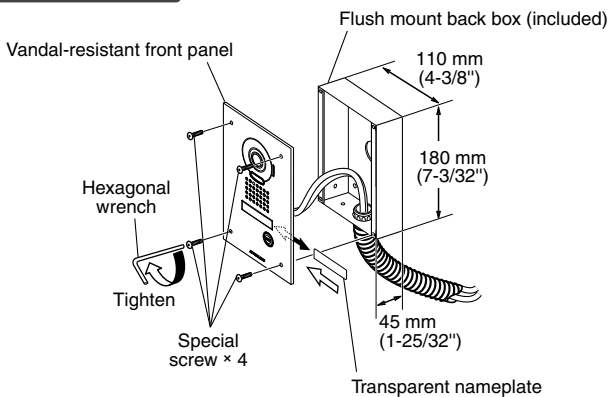

### Using the transparent nameplates

#### Inserting the transparent nameplates

- Remove the vandal-resistant front panel from the flush mount back box.
- Peel off the protective seals on the plate (both sides).
- Fill in the name of the resident on the transparent nameplate.
  - Be sure to leave 25 mm (1") of white space on the right end to account for insertion.
- Insert the filled-in transparent nameplate at the specified insertion opening on the rear side of the vandal-resistant front panel (indicated with ← in diagram).

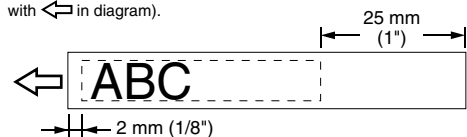

\* Remove protective film from camera before use.

## WIRING

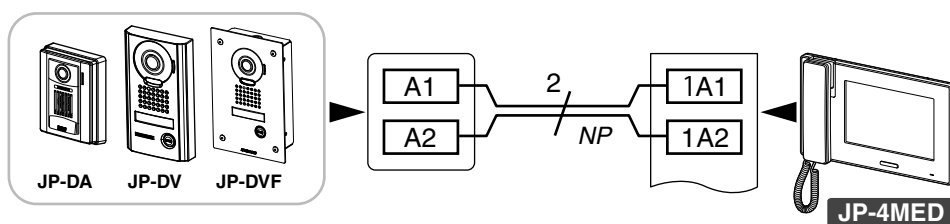

NP: Non-polarized

## TECHNICAL PRECAUTIONS

- Door station is weather resistant. However, do not spray high pressure water on door station directly. Unit trouble could result.
- Cleaning:
  - Clean units with a soft cloth and gentle cleaner. Do not spray cleaner directly on unit. Do not use an abrasive cleanser or cloth.
  - Wipe away dirt from the lens softly with a soft cloth. Observe the following points for lens care.
    - Take care not to scratch the lens.
    - Do not use organic solvents other than isopropyl alcohol (IPA) and methanol.
    - Do not use thinner, benzene, etc. It may cause damage or discoloration to the surface of the unit.

## SPECIFICATIONS

Power supply	Supplied from master station	
Operating temperature	- 10 - 60°C (+14°F - +140°F)	
Camera unit	Complementary metal oxide semiconductor (CMOS)	
Scanning lines	525 lines	
Minimum subject illumination	5 Lux at 50 cm (1'6") distance	
Dimensions	JP-DA	129 (H) x 97 (W) x 30.5 (D) (mm) 5-1/8 (H) x 3-7/8 (W) x 1-3/16 (D) (inches)
	JP-DV	173 (H) x 98 (W) x 27.1 (D) (mm) 6-13/16 (H) x 3-7/8 (W) x 1-1/16 (D) (inches)
	JP-DVF	209 (H) x 135 (W) x exposed area 5.6 (D) (mm) 8-1/4 (H) x 5-5/16 (W) x 7/32 (D) (inches)
	Flush mount back box (JP-DVF)	180 (H) x 110 (W) x 45 (D) (mm) 7-3/32 (H) x 4-3/8 (W) x 1-25/32 (D) (inches)
Mass	JP-DA	Approx. 170 g (0.37 lbs.)
	JP-DV	Approx. 650 g (1.43 lbs.)
	JP-DVF	Approx. 570 g (1.26 lbs.)
	Flush mount back box (JP-DVF)	Approx. 450 g (1.0 lbs.)

# PRECAUTIONS

-  Mesures générales d'interdiction
  Interdiction de démonter l'appareil
  Interdiction d'exposer l'appareil à l'eau
  Précautions générales

## ⚠ AVERTISSEMENT

**Le non-respect de cet avertissement risque d'entraîner des blessures graves, voire mortelles.**

- ❗ 1. Ne démontez pas et ne modifiez pas l'unité. Vous risqueriez de provoquer un incendie ou un choc électrique.
- ❗ 2. Le câblage existant peut être conducteur d'électricité CA. Ceci peut endommager l'appareil et provoquer un incendie ou une décharge électrique. Faites réaliser les opérations de câblage par un technicien qualifié.
- ❗ 3. Cet appareil n'est pas à l'épreuve des explosions. N'installez pas ou n'utilisez pas l'unité dans des endroits présentant des gaz inflammables, tels que des salles à oxygène. Un incendie ou une explosion peut survenir.

## ⚠ ATTENTION

**Le non-respect de cet avertissement risque d'entraîner des blessures ou des dégâts matériels.**

- ❗ 1. Avant de brancher le bloc d'alimentation, vérifiez que les fils ne sont pas croisés ou en court-circuit. Dans le cas contraire, cela pourrait provoquer un incendie ou un choc électrique.
- ❗ 2. Ne réalisez aucune connexion de fil lorsque l'appareil est branché, sous peine de provoquer une décharge électrique ou d'endommager l'unité.

## PRÉCAUTIONS GÉNÉRALES

1. Le poste de porte est protégé contre les intempéries, cependant ne pulvérisez pas d'eau sous haute pression directement sur le poste de porte. Cela risquerait en effet de provoquer une panne de l'appareil.

# CONTENU DE L'EMBALLAGE

Vérifiez que les éléments suivants sont inclus.

JP-DA

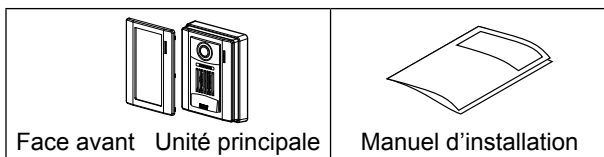

JP-DV

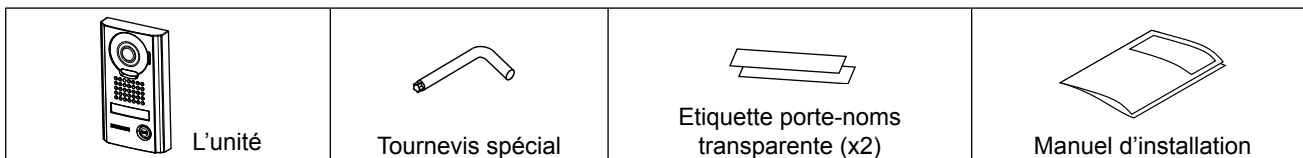

JP-DVF

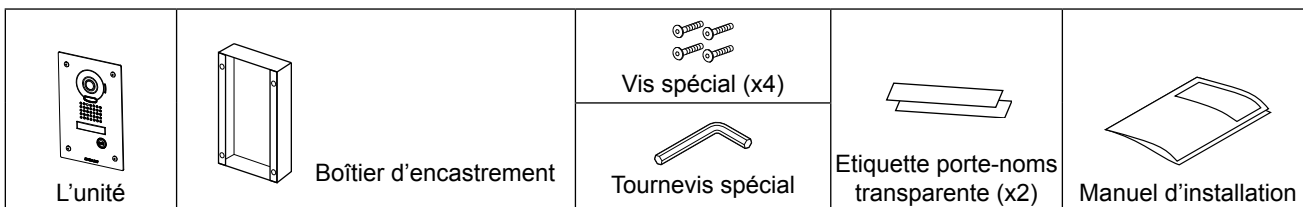

# INSTALLATION

## Emplacements de montage

N'installez pas le portier vidéo aux endroits repris ci-dessous où l'éclairage et l'environnement ambiant pourrait affecter l'affichage sur le moniteur vidéo intérieur.

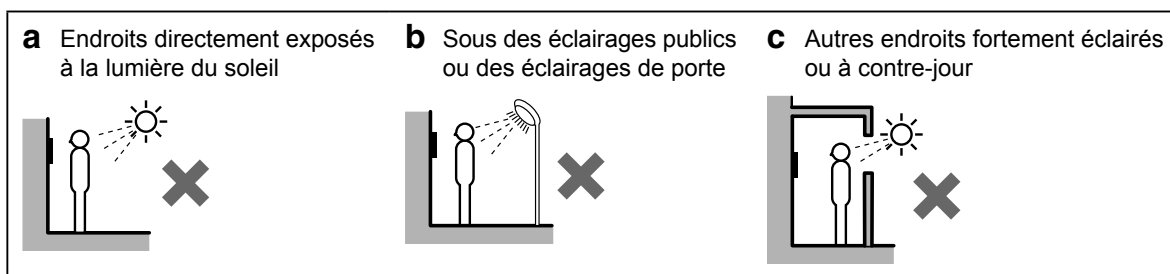

## Positions de montage et zone de vision de l'image

◇ Image plein écran

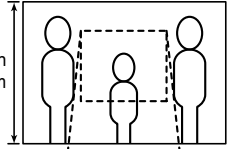

Environ 1 300 mm

◆ Les objets apparaissent plus petits à cause d'une plus grande distorsion dans les sections environnantes par rapport à la partie centrale, mais ainsi, une zone plus grande est affichée. La plage d'affichage est une estimation brute et peut varier suite à l'environnement d'installation.

◇ Image Zoom

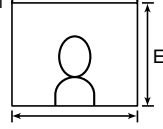

Environ 600 mm

Environ 950 mm

◆ La position du zoom peut être modifiée. (Cf. Se reporter au manuel d'utilisation du poste maître.) Le réglage par défaut du mode Zoom est "Centré".

◇ Image plein écran

**Haut/bas** Position de montage

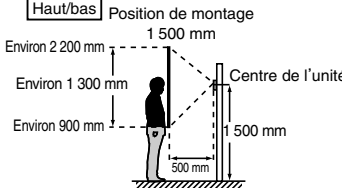

Environ 2 200 mm

1 500 mm

Environ 1 300 mm

Environ 900 mm

Centre de l'unité

1 500 mm

**Position de montage**

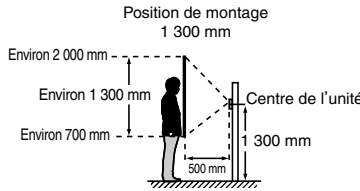

1 300 mm

Environ 2 000 mm

Environ 1 300 mm

Centre de l'unité

1 300 mm

Environ 700 mm

**Gauche/droite**

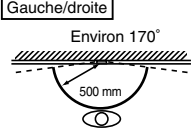

Environ 170°

500 mm

◆ Une zone de couverture s'affiche, d'environ 170° avec un rayon de 500 mm à partir de la caméra. (La plage d'affichage est une estimation brute et peut varier suite à l'environnement de l'installation.)

---

◇ Image de zoom (lorsque la position de montage est de 1 500 mm)

**Haut/bas**

**Zoom <Haut>**

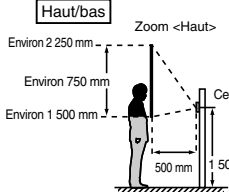

Environ 2 250 mm

Environ 750 mm

Environ 1 500 mm

Centre de l'unité

1 500 mm

**Zoom <Centre>**

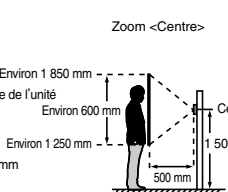

Environ 1 850 mm

Environ 600 mm

Environ 1 250 mm

Centre de l'unité

1 500 mm

**Zoom <Bas>**

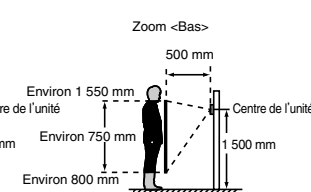

500 mm

Environ 1 550 mm

Environ 750 mm

Environ 800 mm

Centre de l'unité

1 500 mm

**Gauche/droite**

**Zoom <Gauche>**

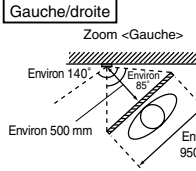

Environ 140°

Environ 500 mm

Environ 950 mm

**Zoom <Centre>**

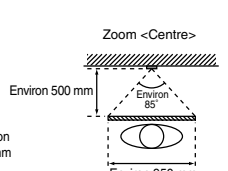

Environ 85°

Environ 500 mm

Environ 950 mm

**Zoom <Droite>**

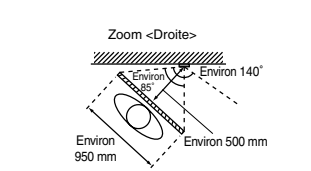

Environ 140°

Environ 500 mm

Environ 950 mm

## Câble

- Il est recommandé d'utiliser un câble téléphonique LYT1 8/10ème. Il est recommandé d'utiliser un câble à gaine PVC isolée PE (polyéthylène).
- N'utilisez jamais de conducteurs individuels, de câble à paires torsadées ou de câble coaxial.

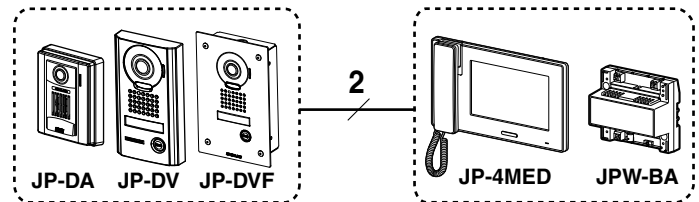

## Longueur de câblage

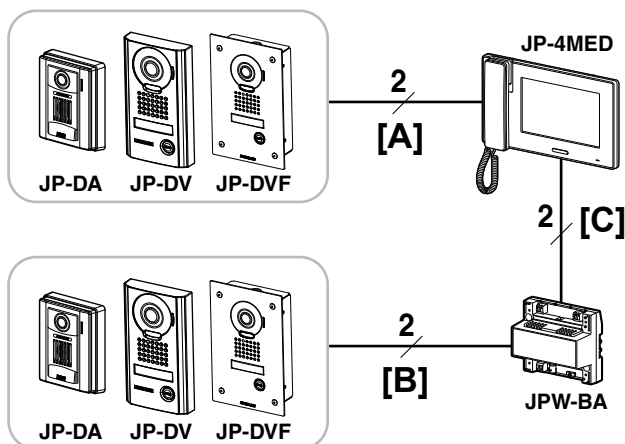

		Diamètre du câble			
		Ø0,65 mm	Ø0,8 mm	Ø1,0 mm	Ø1,2 mm
[A]	Poste porte - poste maître	50 m	100 m	100 m	100 m
[B]	Poste porte - adaptateur longue distance	100 m	150 m	200 m	200 m
[C]	Adaptateur longue distance - poste maître	50 m	75 m	100 m	100 m

# MONTAGE

## JP-DA

### ① Retirer l'unité principale de son étrier

Retirez l'unité principale.  
(Dévissez les vis de montage).

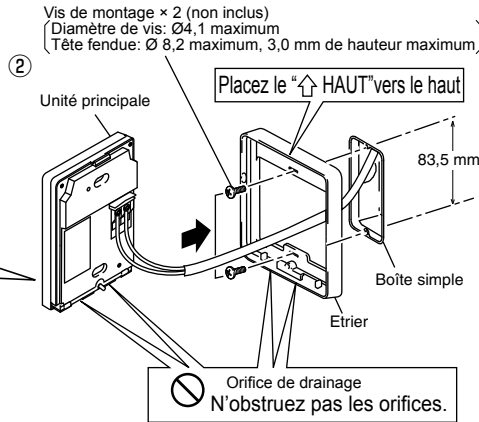
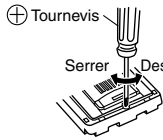

### ③ Montez l'unité principale sur l'étrier et fixez la face avant.

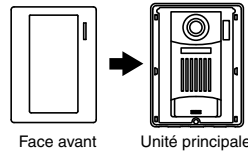

### Retrait de la face avant

<Surface inférieure>

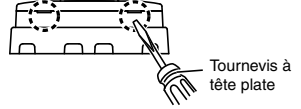

Soulevez la face avant à l'aide d'un tournevis plat.

## JP-DV

Cheville x 4 (non inclus)  
(Préparez les chevilles en fonction de la taille des vis de montage.)

(Le diamètre et la profondeur des trous dans le mur dépendent des systèmes de fixation utilisés, ces derniers devant être adaptés aux vis de montage utilisées.)

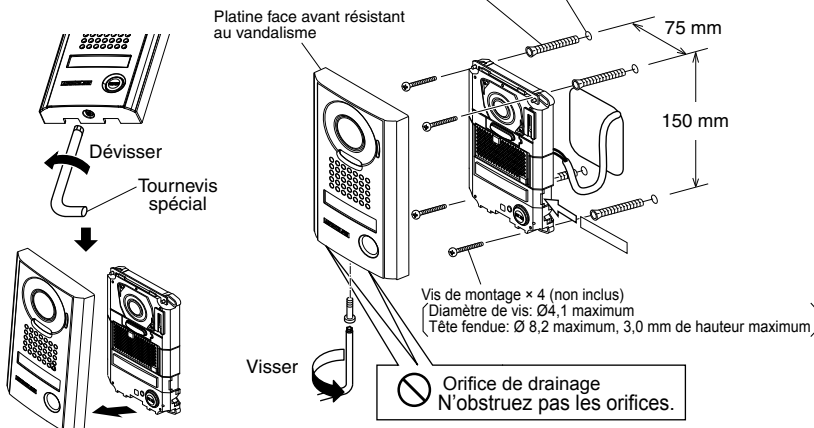

\* Retirez le film protecteur de la caméra avant de l'utiliser.

### Utilisation des étiquettes porte-noms transparentes

#### Insertion des étiquettes porte-noms transparentes

- ① Retirez la face avant résistant au vandalisme.
- ② Détachez les joints de protection sur la plaque (les deux côtés).
- ③ Ecrivez le nom du résidant sur l'étiquette porte-nom transparente.
- ⚠ Assurez-vous de laisser 25 mm d'espace blanc à l'extrémité droite afin de prendre en compte l'insertion.
- ④ Insérez l'étiquette porte-noms transparente complétée dans l'ouverture d'insertion spécifiée (indiquée par ↔ sur le schéma).

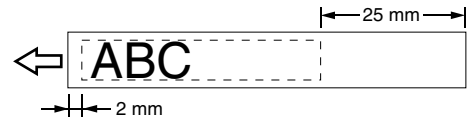
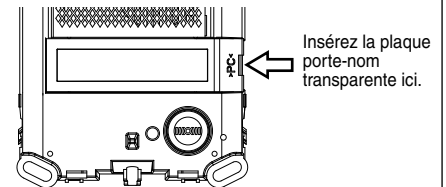

## JP-DVF

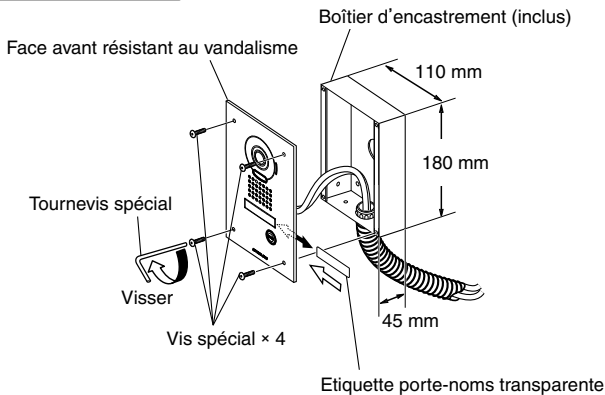

\* Retirez le film protecteur de la caméra avant de l'utiliser.

### Utilisation des étiquettes porte-noms transparentes

#### Insertion des étiquettes porte-noms transparentes

- ① Retirez la face avant de la platine résistant au vandalisme du boîtier d'encastement.
- ② Détachez les joints de protection sur la plaque (les deux côtés).
- ③ Ecrivez le nom du résidant sur l'étiquette porte-nom transparente.
- ⚠ Assurez-vous de laisser 25 mm d'espace blanc à l'extrémité droite afin de prendre en compte l'insertion.
- ④ Insérez l'étiquette porte-nom transparente remplie dans l'ouverture d'insertion spécifiée sur le côté arrière de la platine avant antivandale (indiquée par un ↔ dans le schéma).

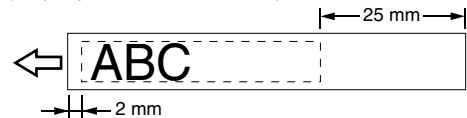



## CABLAGE

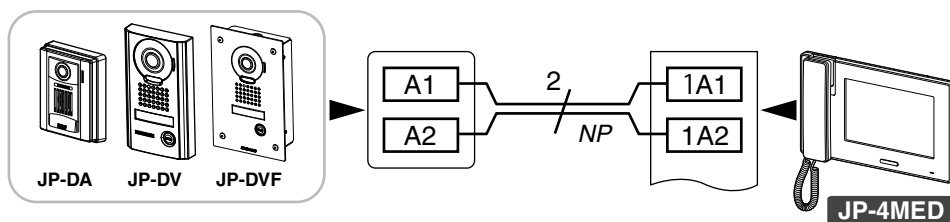

NP: non polarisé

## PRECAUTIONS TECHNIQUES

- Le poste de porte résiste aux intempéries. Cependant, ne pas vaporiser de l'eau à haute pression directement sur un poste de porte. Cela risquerait en effet de provoquer une panne de l'appareil.
- Nettoyage:
  - Nettoyez les unités avec un chiffon et un produit de nettoyage doux. Ne pulvérisiez pas le produit de nettoyage directement sur l'unité. Ne jamais utiliser de produit de nettoyage ou de chiffon abrasif.
  - Essuyez en douceur les saletés sur l'objectif avec un chiffon doux. Respectez les points suivants pour l'entretien de l'objectif.
    - Faites attention de ne pas rayer l'objectif.
    - N'utilisez pas de solvants organiques autres que de l'alcool isopropylique (IPA) et du méthanol.
    - N'utilisez pas de diluant, de benzène, etc., car cela risque de provoquer des dommages ou une décoloration sur la surface de l'appareil.

## SPECIFICATIONS

Bloc d'alimentation	Fourni par poste maître	
Température de fonctionnement	de - 10 à 60°C	
Caméra	Semi-conducteur à oxyde de métal complémentaire (CMOS)	
Lignes de balayage	525 lignes	
Eclairage minimum du sujet	5 Lux à 50 cm de distance	
Dimensions	JP-DA	129 (H) x 97 (L) x 30,5 (P) (mm)
	JP-DV	173 (H) x 98 (L) x 27,1 (P) (mm)
	JP-DVF	209 (H) x 135 (L) x 5,6 (P) de zone exposée (mm)
	Boîtier d'encastrement (JP-DVF)	180 (H) x 110 (L) x 45 (P) (mm)
Poids	JP-DA	Environ 170 g
	JP-DV	Environ 650 g
	JP-DVF	Environ 570 g
	Boîtier d'encastrement (JP-DVF)	Environ 450 g

# PRECAUCIONES

- Prohibición de desmantelar la unidad
 Prohibición de exponer la unidad al agua
 Precauciones generales

## ⚠ ADVERTENCIA

**No seguir estas instrucciones podría provocar lesiones graves o incluso la muerte.**

1. No desmantele ni modifique la unidad. Existe peligro de incendio o descarga eléctrica.
2. El alambrado existente, como el cableado de timbre, etc. puede contener electricidad CA de alta tensión. Existe peligro de daños en el aparato o descargas eléctricas. El cableado y la instalación debe realizarla un técnico calificado.
3. Esta unidad no es una unidad a prueba de explosiones. No instale ni use la unidad en lugares llenos de gas inflamable, tales como cuartos de oxígeno. Puede producirse un incendio o una explosión.

## ⚠ PRECAUCIÓN

**No seguir estas instrucciones podría causar daños físicos o materiales.**

1. Antes de encender la unidad, asegúrese de que no haya ningún cable cruzado o en cortocircuito. De lo contrario, podrían producirse incendios o descargas eléctricas.
2. No instale ni realice terminaciones de alambres mientras la unidad esté enchufada, ya que podría producir descargas eléctricas y dañar la unidad.

## PRECAUCIONES GENERALES

1. El portero es resistente al ambiente, pero no se rocíe con agua de alta presión sobre la puerta de forma directa. La unidad podría resultar dañada.

# CONTENIDO DEL PAQUETE

Verifique que se hayan incluido las siguientes piezas.

JP-DA

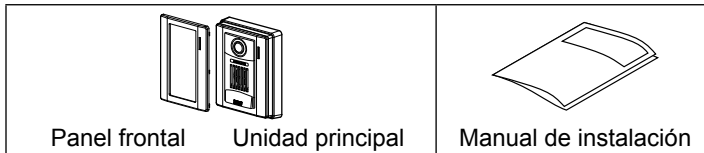

JP-DV

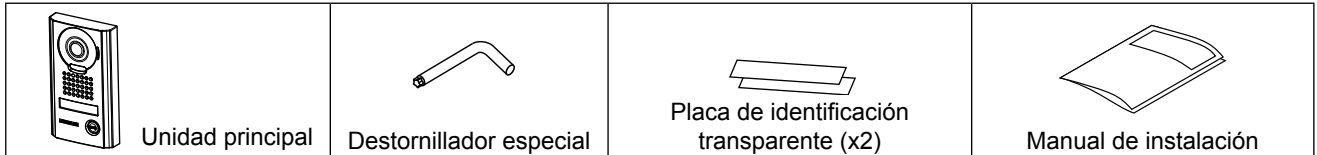

JP-DVF

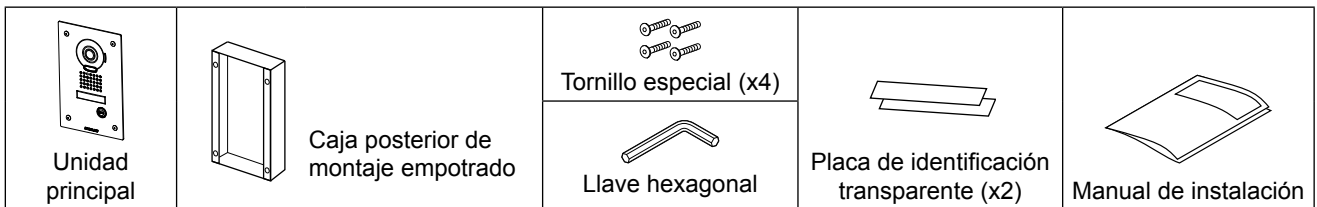

# INSTALACIÓN

## Ubicaciones de montaje

"No instale el video portero en ninguno de los siguientes lugares donde el alumbrado o el medio ambiente podrían impactar la visualización en el videomonitor debido a las características de la cámara del portero."

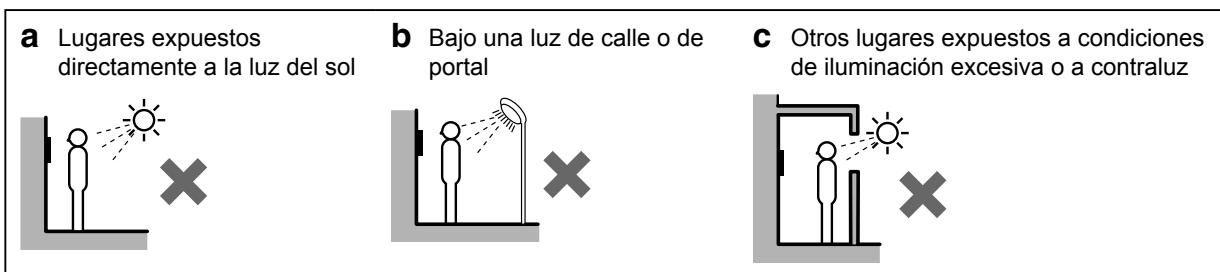

## Posiciones de montaje y área de visión

◇ Imagen wide

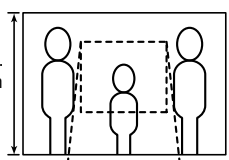

◆ Los objetos parecen más pequeños debido a mayor distorsión en secciones circundantes en comparación con la sección central, pero se visualiza un área más amplia. El alcance de la visualización es un cálculo aproximado y puede cambiar debido al ambiente de la instalación.

◇ Imagen zoom

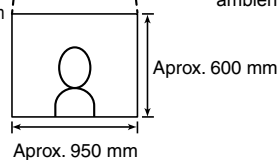

◆ La posición del zoom (acercamiento) puede cambiarse. (Referirse al manual de funcionamiento del aparato principal.) La configuración de fábrica del modo Zoom es "Centro".

◇ Imagen wide

**Arriba/Abajo**

Posición de montaje 1.500 mm

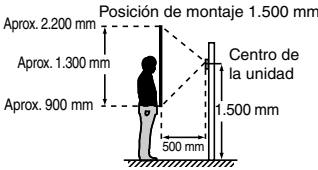

Posición de montaje 1.300 mm

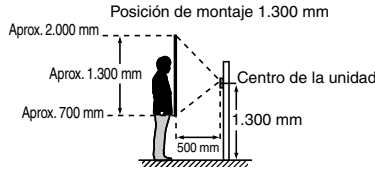

**Izquierda/Derecha**

Aprox. 170°

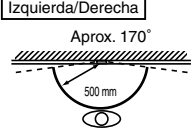

◆ Se visualiza un área sobre un alcance de aprox. 170° en un radio de 500 mm desde la cámara. (El alcance de la visualización es un cálculo aproximado y puede cambiar debido al ambiente de la instalación.)

◇ Imagen zoom (cuando la posición de montaje es de 1.500 mm)

**Arriba/Abajo**

Zoom <Arriba>

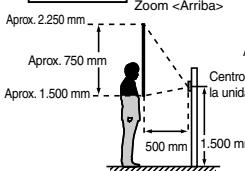

Zoom <Centro>

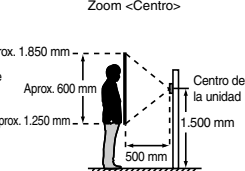

Zoom <Abajo>

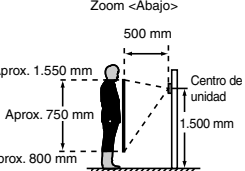

**Izquierda/Derecha**

Zoom <Izquierda>

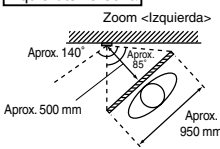

Zoom <Centro>

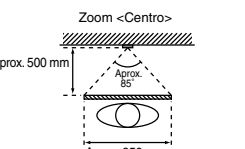

Zoom <Derecha>

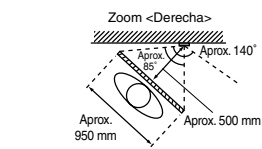

## Cable

- Use cable con revestimiento de PVC aislado con PE (Polietileno). Se recomienda el uso de cable sin funda, de media capacitancia, de 2 conductores paralelo o con pantalla.
- Nunca use conductores individuales, cable de par trenzado o cable coaxial.

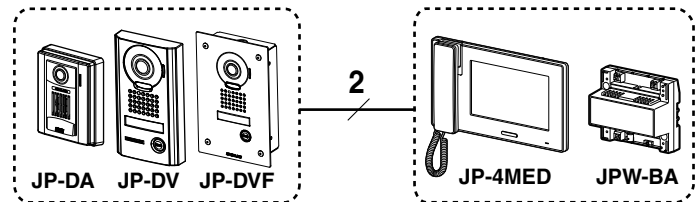

## Distancia entre cables

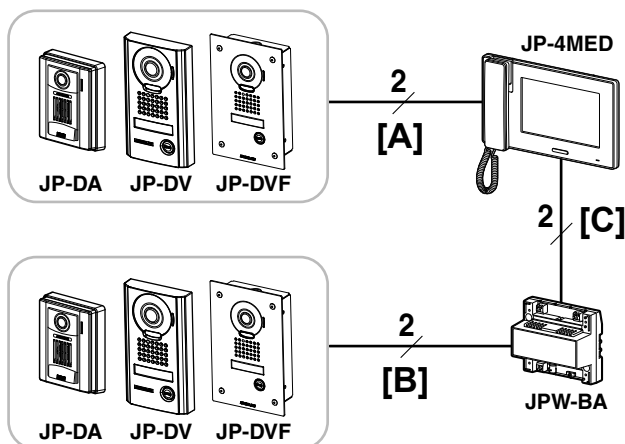

		Diámetro del cable			
		Ø0,65 mm	Ø0,8 mm	Ø1,0 mm	Ø1,2 mm
[A]	Estación de puerta - Monitor principal	50 m	100 m	100 m	100 m
[B]	Estación de puerta - Adaptador de larga distancia	100 m	150 m	200 m	200 m
[C]	Adaptador de larga distancia - Monitor principal	50 m	75 m	100 m	100 m

# MONTAJE

## JP-DA

### ① Retirando la unidad principal del cuadro de montaje

Retire la unidad principal. (Afloje los tornillos de bloqueo.)

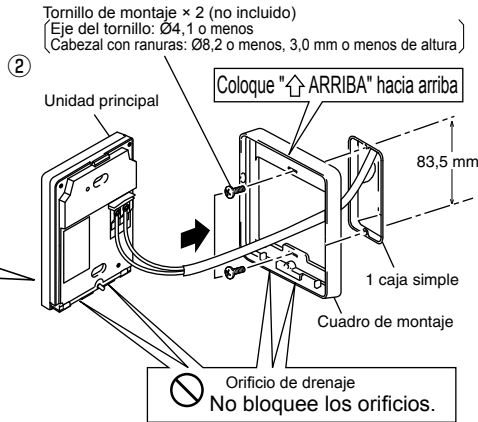
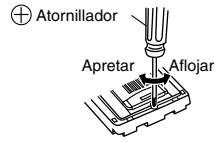

### ③ Monte la unidad principal en el cuadro de montaje y coloque el panel frontal.

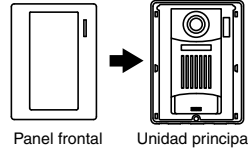

### Para retirar el panel frontal

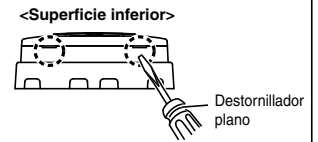

Quite el panel frontal haciendo palanca con un destornillador plano.

## JP-DV

Taco x 4 (no incluido)  
(Prepare los tacos acorde con el tamaño de los tornillos de montaje.)

(El diámetro y la profundidad de los orificios en el muro dependen de los tacos adecuados para los tornillos de montaje utilizados.)

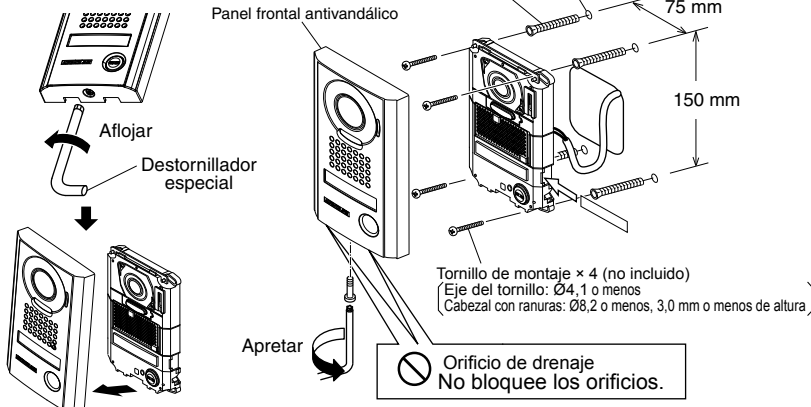

\* Quite la película protectora de la cámara antes del uso.

### Cómo usar las placas de identificación transparentes

#### Para insertar las placas de identificación transparentes

- ① Retire el panel frontal antivandálico
- ② Desprenda los sellos de protección en la placa (ambos lados).
- ③ Anote el nombre del residente en la placa de identificación transparente.  
⚠ No olvide dejar 25 mm de espacio en blanco en la parte derecha (quedará oculto tras la inserción).
- ④ Inserte la placa de identificación transparente con el nombre en la abertura de inserción especificada (indicada con ← en el diagrama) de la siguiente manera.

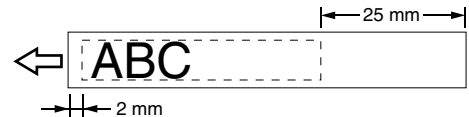
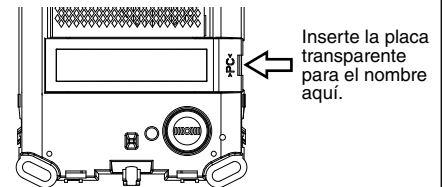

## JP-DVF

Panel frontal antivandálico

Caja posterior de montaje empotrado (incluida)

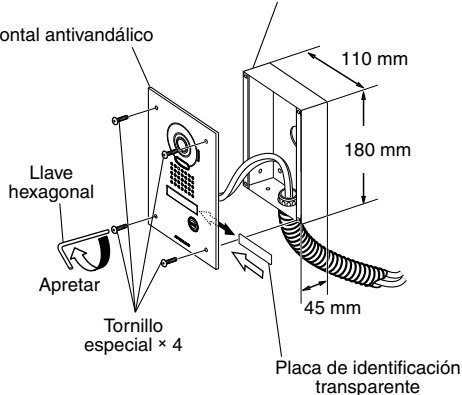

### Cómo usar las placas de identificación transparentes

#### Para insertar las placas de identificación transparentes

- ① Retire el panel frontal antivandálico de la caja posterior de montaje empotrado.
- ② Desprenda los sellos de protección en la placa (ambos lados).
- ③ Anote el nombre del residente en la placa de identificación transparente.  
⚠ No olvide dejar 25 mm de espacio en blanco en la parte derecha (quedará oculto tras la inserción).
- ④ Inserte la placa de identificación transparente con el nombre en la abertura de inserción especificada (indicada con ← en el diagrama), en la parte posterior del panel frontal antivandálico.

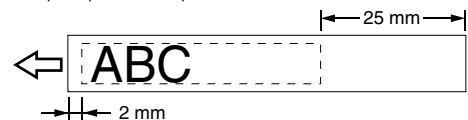

\* Quite la película protectora de la cámara antes del uso.

## CABLEADO

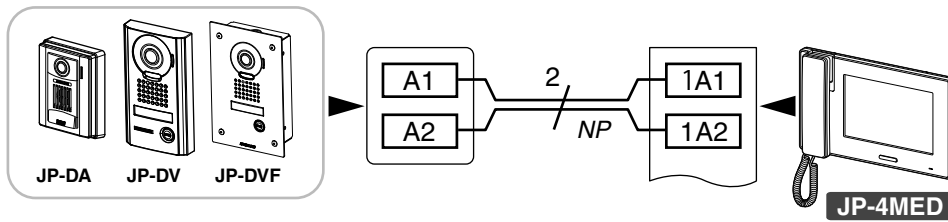

NP: No polarizado





## PRECAUCIONES DE ORDEN TÉCNICO

- El portero es resistente al ambiente. Sin embargo, no se recomienda que lo rocíe con agua a alta presión directamente. La unidad podría resultar dañada.
- Limpieza:
  - Limpie los equipos con un paño suave y limpiador moderado. No rocíe limpiador directamente al equipo. No utilice un producto de limpieza ni un paño que sean abrasivos.
  - Limpie el polvo del objetivo suavemente con un paño suave. Tenga en cuenta las siguientes indicaciones para el cuidado de la lente.
    - Tenga cuidado de no rayar la lente.
    - No utilice disolventes orgánicos que no sea alcohol isopropílico (IPA) y metanol.
    - No utilice disolventes, bencina, etc. Puede provocar daños o decoloración en la superficie de la unidad.

## ESPECIFICACIONES

Fuente de alimentación	Proporcionada por el monitor principal	
Temperatura de operación	- 10 - 60°C	
Cámara	Semiconductor de óxido de metal complementario (CMOS)	
Líneas de exploración	525 líneas	
Iluminación mínima de sujeto	5 Lux a una distancia de 50 cm	
Dimensiones	JP-DA	129 (altura) x 97 (ancho) x 30,5 (profundidad) (mm)
	JP-DV	173 (altura) x 98 (ancho) x 27,1 (profundidad) (mm)
	JP-DVF	209 alto x 135 ancho x área expuesta 5,6 de profundidad (mm)
	Caja posterior de montaje empotrado (JP-DVF)	180 (altura) x 110 (ancho) x 45 (profundidad) (mm)
Peso	JP-DA	Aproximadamente 170 g
	JP-DV	Aproximadamente 650 g
	JP-DVF	Aproximadamente 570 g
	Caja posterior de montaje empotrado (JP-DVF)	Aproximadamente 450 g

# VOORZORGSMAATREGELEN

-  Algemeen verbod
  Verbod om het toestel te demonteren
  Verbod om het toestel met water in contact te brengen
  Algemene voorzorgsmaatregelen

## ⚠ WAARSCHUWING

**Niet-naleving kan de dood of ernstig lichamelijk letsel veroorzaken.**

1. Demonteer of verander het toestel niet. Dit kan brand of elektrische schokken veroorzaken.
2. Bestaande bedrading zoals bedrading van een bel, enz. kan hoogspanningswisselstroom bevatten. Dit kan beschadiging van het toestel of elektrische schokken veroorzaken. De bedrading en installatie moeten door een vakman worden uitgevoerd.
3. Dit toestel is niet bestand tegen explosies. Gebruik of installeer het toestel niet op plaatsen waar ontvlambaar gas aanwezig is, zoals zuurstofkamers. Dit kan brand of een explosie veroorzaken.

## ⚠ OPGELET

**Niet-naleving kan lichamelijk letsel of materiële schade veroorzaken.**

1. Controleer of de draden niet gekruist of kortgesloten zijn alvorens de stroom in te schakelen. Zo niet kan brand of een elektrische schok ontstaan.
2. Sluit niets aan of sluit geen draden af terwijl de voeding is aangesloten. Dit kan elektrische schokken of schade aan het toestel veroorzaken.

## ALGEMENE VOORZORGSMAATREGELEN

1. De buitenpost is weerbestendig, maar spuit geen water onder hoge druk rechtstreeks op de buitenpost. Dit kan het toestel beschadigen.

# INHOUD VAN DE VERPAKKING

Controleer of de volgende onderdelen zijn meegeleverd.

**JP-DA**

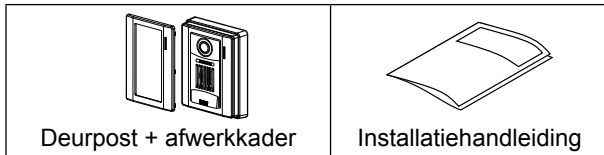

**JP-DV**

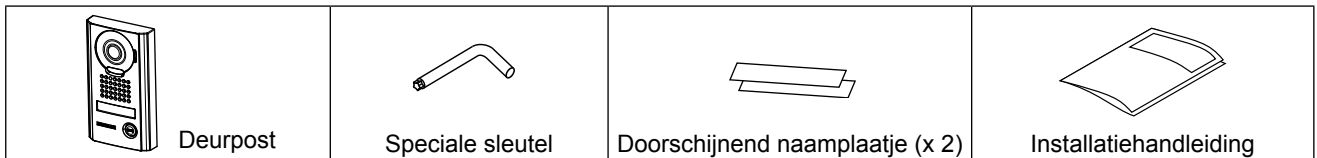

**JP-DVF**

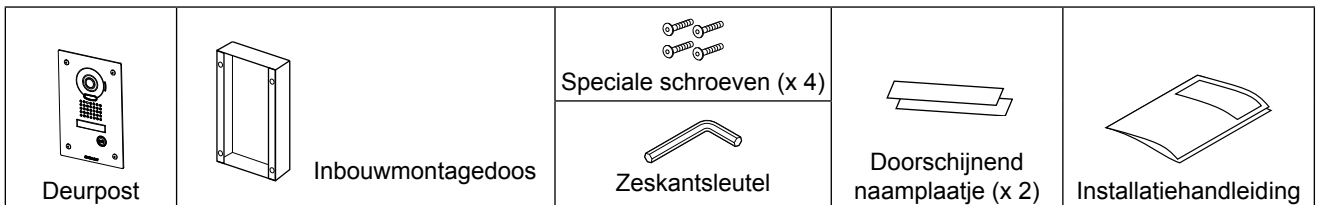

# INSTALLATIE

## Montageplaatsen

Voor een optimale beeldkwaliteit dient de deurpost zodanig te worden opgesteld dat er geen lichtbron komt achter het object dat in beeld wordt gebracht (tegenlicht).

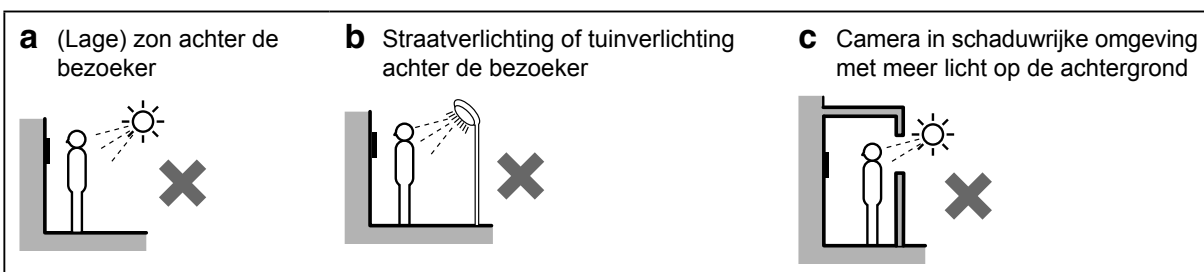

## Montagestanden en gezichtsveld

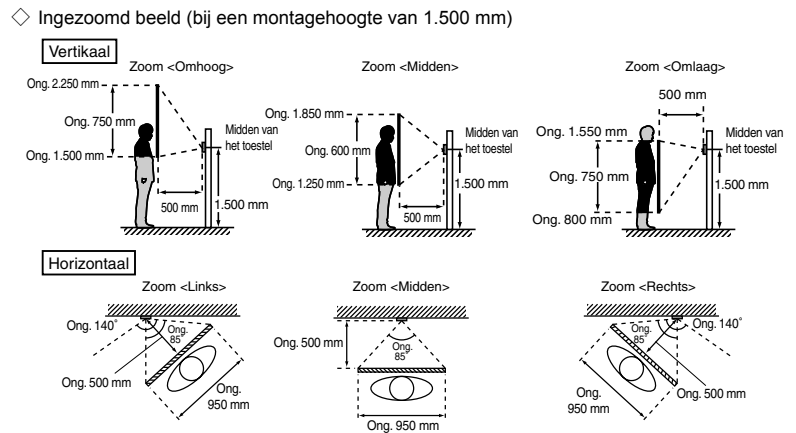
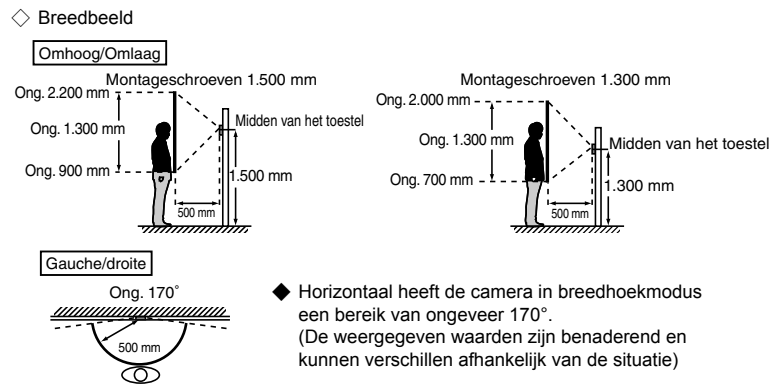
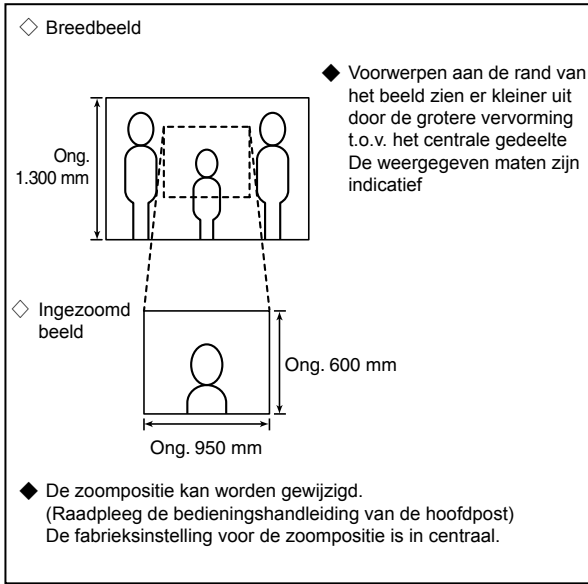

## Kabel

- Gebruik kabel met massieve geleiders, voorzien van polyethyleenisolatie.
- Gebruik nooit individuele geleiders of coaxkabel.

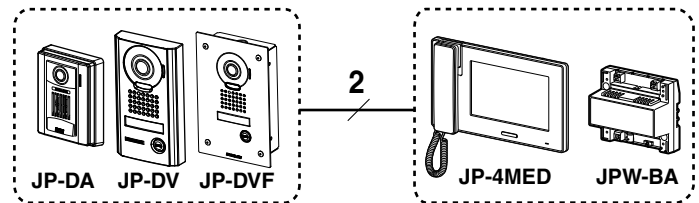

## Bekabelingsafstand

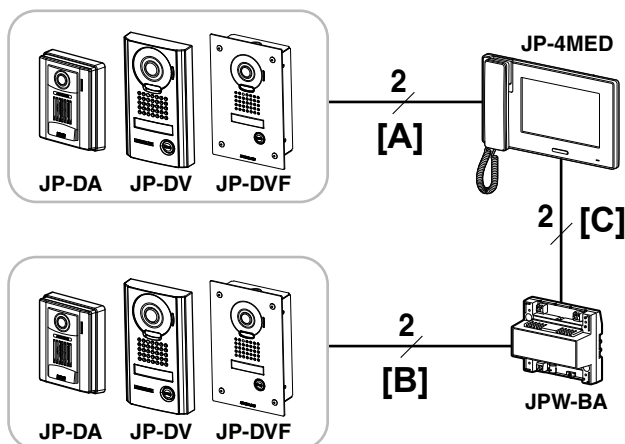

	Kabeldiameter			
	Ø0,65 mm	Ø0,8 mm	Ø1,0 mm	Ø1,2 mm
[A] Deurpost - hoofdpost	50 m	100 m	100 m	100 m
[B] Deurpost - langeafstandsadapter	100 m	150 m	200 m	200 m
[C] Langeafstandsadapter - hoofdpost	50 m	75 m	100 m	100 m

# MONTAGE

## JP-DA

### ① De deurpost van het montagekader verwijderen.

Draai de schroeven los om het kader te demonteren

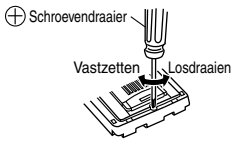

Montageschroeven × 2 (niet meegeleverd)  
(Schroefas: Ø 4,1 of minder  
Kop: Ø 8,2 of minder, 3,0 mm of minder hoog)

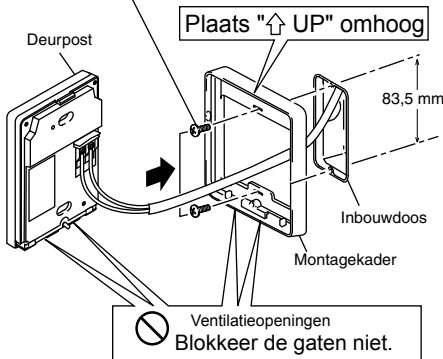

### ③ Monteer de deurpost terug op het montagekader, en plaats er het afwerkkader op.

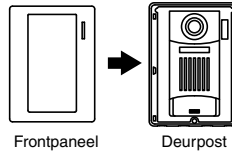

### Afwerkkader verwijderen

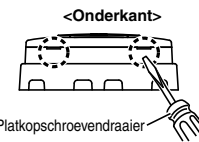

Haal het frontpaneel eraf met een platkopschroevendraaier.

## JP-DV

Plug x 4 (niet inbegrepen)  
(Bereid pluggen voor met een geschikte grootte voor de bijgeleverde montageschroeven.)

(De diameter en de diepte van de gaten in de muur zijn afhankelijk van de pluggen en de gebruikte montageschroeven.)

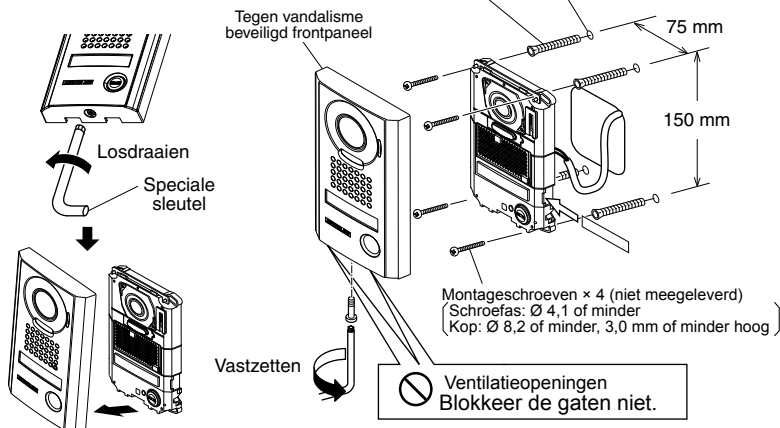

\* Verwijder de beschermfolie van de camera voor gebruik.

### De doorschijnende naamplaatjes gebruiken

#### De doorschijnende naamplaatjes insteken

- ① Verwijder het tegen vandalisme beveiligd frontpaneel.
- ② Verwijder de beschermende folie van het plaatje (beide zijden).
- ③ Vul de naam van de bewoner in op het doorschijnende naamplaatje.  
⚠ Zorg dat u rechts 25 mm vrije ruimte overhoudt voor het inbrengen van het plaatje.
- ④ Schuif het ingevulde doorzichtige naamplaatje in de gespecificeerde inschuifopening (aangegeven met ← in de tekening) zoals hieronder wordt getoond.

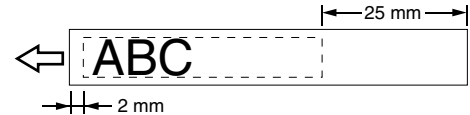
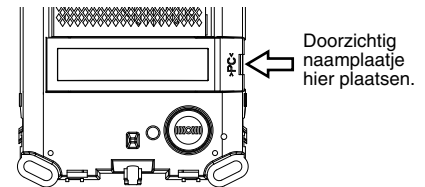

## JP-DVF

Tegen vandalisme beveiligd frontpaneel

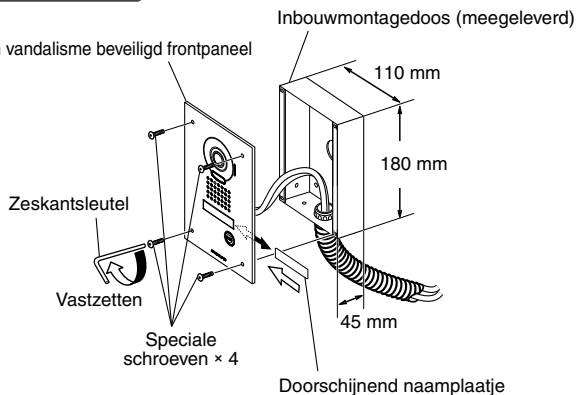

\* Verwijder de beschermfolie van de camera voor gebruik.

### De doorschijnende naamplaatjes gebruiken

#### De doorschijnende naamplaatjes insteken

- ① Verwijder het tegen vandalisme beveiligd frontpaneel van de inbouwmontagedoos.
- ② Verwijder de beschermende folie van het plaatje (beide zijden).
- ③ Vul de naam van de bewoner in op het doorschijnende naamplaatje.  
⚠ Zorg dat u rechts 25 mm vrije ruimte overhoudt voor het inbrengen van het plaatje.
- ④ Steek het ingevulde doorschijnende naamplaatje in de voorgeschreven insteekopening aan de achterkant van het tegen vandalisme beveiligd frontpaneel (op het schema aangeduid met ←).

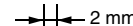
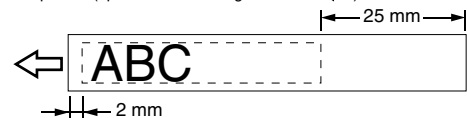



## BEDRADING

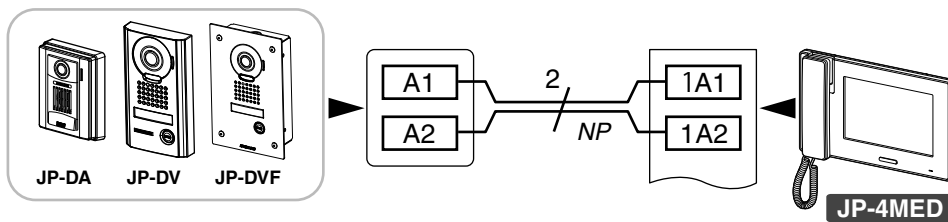

NP: Niet-gepolariseerd

## TECHNISCHE VOORZORGSMAATREGELEN

- De buitenpost is weerbestendig, maar spuit geen water onder hoge druk rechtstreeks op de buitenpost. Dit kan het toestel beschadigen.
- Reiniging:
  - Maak de toestellen met een zachte doek en een neutraal reinigingsmiddel schoon. Gebruik geen schoonmaakspray rechtstreeks op het toestel. Gebruik geen schurend reinigingsmiddel of doek.
  - Veeg vuil op de lens voorzichtig af met een zachte doek. Houd u aan de volgende punten voor onderhoud van de lens.
    - Let op dat u geen krassen maakt op de lens.
    - Gebruik geen organische oplosmiddelen behalve isopropylalcohol (IPA) en methanol.
    - Gebruik geen verfverdunder, benzeen enz. Deze kunnen beschadiging of verkleuring van het oppervlak van het toestel veroorzaken.

## TECHNISCHE GEGEVENS



Voeding	Geleverd door hoofdpst	
Bedrijfstemperatuur	- 10 - 60 °C	
Camera	CMOS-technologie	
Videostandaard	NTSC	
Minimale verlichting	5 Lux op 50 cm afstand	
Afmetingen	JP-DA	129 (H) x 97 (W) x 30,5 (D) (mm)
	JP-DV	173 (H) x 98 (W) x 27,1 (D) (mm)
	JP-DVF	209 (H) x 135 (B) x blootgestelde zone 5,6 (D) (mm)
	Inbouwmontagedoos (JP-DVF)	180 (H) x 110 (W) x 45 (D) (mm)
Gewicht	JP-DA	Circa 170 g
	JP-DV	Circa 650 g
	JP-DVF	Circa 570 g
	Inbouwmontagedoos (JP-DVF)	Circa 450 g

# PRECAUZIONI

-  Divieti generici
-  Divieto di smontare l'unità
-  Divieto di esporre l'unità all'acqua
-  Precauzioni generali



## AVVERTENZA

**Il mancato rispetto di quanto indicato potrebbe causare lesioni gravi o incidenti anche mortali.**

-  1. Non smontare, non manomettere l'unità. Pericolo di incendio o di scarica elettrica.
-  2. I cavi esistenti, per esempio quelli del cicalino, ecc. potrebbero portare elettricità C.A. ad alta tensione. L'unità potrebbe restare danneggiata oppure si potrebbe verificare una scarica elettrica. La posa dei cavi e l'installazione devono essere effettuate da un tecnico qualificato.
-  3. Quest'unità non è a prova di esplosione. Non installare, non usare l'unità in luoghi saturi di gas infiammabili, per esempio le camere dell'ossigeno. Ne potrebbe derivare un incendio o un'esplosione.

## ATTENZIONE

**Il mancato rispetto di quanto indicato potrebbe causare lesioni alle persone o danni alle cose.**

-  1. Prima di accendere l'unità, assicurarsi che i cavi non siano incrociati né in cortocircuito. In caso contrario, si correrebbe il rischio di un incendio o di scarica elettrica.
-  2. Non installare né eseguire terminazioni con cavi se è collegata l'alimentazione. Tale imprudenza potrebbe causare una scarica elettrica o danneggiare l'unità.

## PRECAUZIONI GENERALI

- 1. La postazione videocitofonica esterna è resistente alle intemperie, ma è bene non spruzzare direttamente sulla postazione getti d'acqua ad alta pressione. L'unità si potrebbe guastare.

# CONTENUTO DELLA CONFEZIONE

Assicurarsi che i seguenti componenti siano inclusi.

**JP-DA**



**JP-DV**

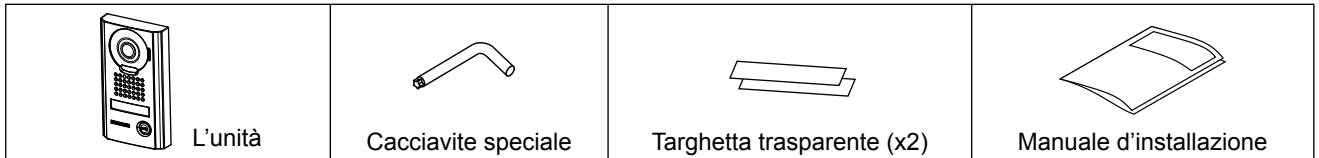

**JP-DVF**

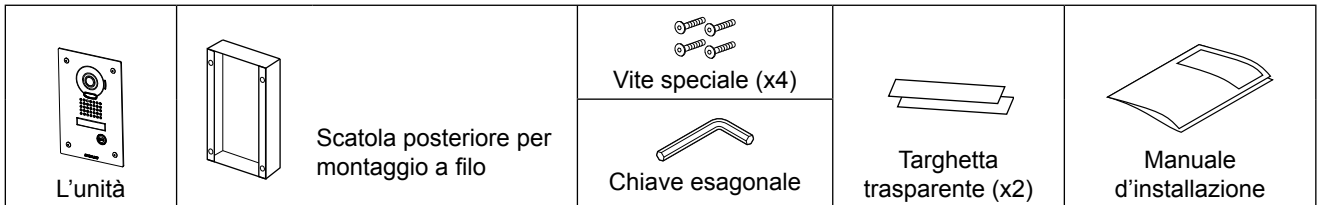

# INSTALLAZIONE

## Luoghi adatti per il montaggio

"Non installare la postazione videocitofonica esterna in nessuno dei luoghi sotto indicati. Luoghi in cui la luce o l'ambiente esterno potrebbero colpire direttamente il display del monitor per via delle caratteristiche della telecamera della postazione videocitofonica esterna."

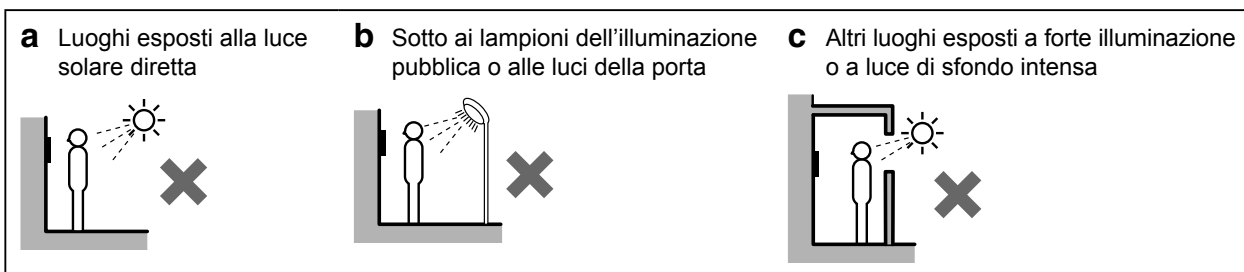

## Posizioni di montaggio ed area di visualizzazione dell'immagine

◇ Immagine ripresa nella modalità grandangolo

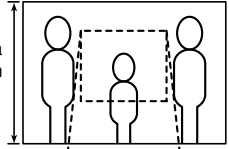

Circa 1.300 mm

◆ Gli oggetti appaiono più piccoli a causa della maggiore distorsione nelle parti di contorno rispetto alla sezione centrale, ma può essere così visualizzata un'area più ampia. Il campo di visualizzazione indicato è una stima approssimativa e può variare in base all'ambiente d'installazione.

◇ Immagine ripresa nella modalità ingrandimento

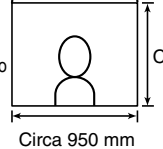

Circa 600 mm

Circa 950 mm

◆ La posizione di ingrandimento può essere variata. (Consultare il manuale d'uso della postazione principale). L'impostazione predefinita è "Centro" per la modalità di ingrandimento.

◇ Immagine ripresa nella modalità grandangolo

**Su/Giù**

Posizione di montaggio 1.500 mm

Circa 2.200 mm

Circa 1.300 mm

Circa 900 mm

Centro dell'unità

1.500 mm

500 mm

Posizione di montaggio 1.300 mm

Circa 2.000 mm

Circa 1.300 mm

Circa 700 mm

Centro dell'unità

1.300 mm

500 mm

**Sinistra/Destra**

Circa 170°

500 mm

◆ Viene visualizzata un'area di circa 170° in un raggio di 500 mm ripresa dall'occhio della telecamera. (Il campo di visualizzazione indicato è una stima approssimativa e può variare in base all'ambiente d'installazione).

◇ Immagine ripresa nella modalità ingrandimento (se la posizione di montaggio è di 1.500 mm)

**Su/Giù**

Ingrandimento <Su>

Circa 2.250 mm

Circa 750 mm

Circa 1.500 mm

Centro dell'unità

1.500 mm

500 mm

Ingrandimento <Centro>

Circa 1.850 mm

Circa 600 mm

Circa 1.250 mm

Centro dell'unità

1.500 mm

500 mm

Ingrandimento <Giù>

500 mm

Circa 1.550 mm

Circa 750 mm

Circa 800 mm

Centro dell'unità

1.500 mm

**Sinistra/Destra**

Ingrandimento <Sinistra>

Circa 140°

Circa 85°

Circa 500 mm

Circa 950 mm

Ingrandimento <Centro>

Circa 500 mm

Circa 85°

Circa 950 mm

Ingrandimento <Destra>

Circa 85°

Circa 140°

Circa 950 mm

Circa 500 mm

## Cavo

- Utilizzare cavi isolanti rivestiti in PVC PE (polietilene). È consigliato l'uso di un cavo non schermato, di capacità media a 2 conduttori rivestiti o in parallelo.
- Non utilizzare mai conduttori singoli, un cavo a doppini intrecciati o un cavo coassiale.

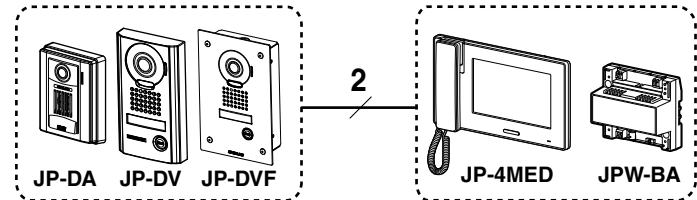

## Distanza di cablaggio

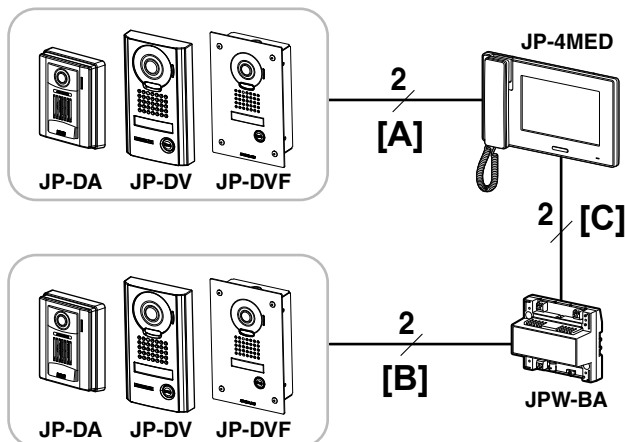

		Diametro del cavo			
		Ø0,65 mm	Ø0,8 mm	Ø1,0 mm	Ø1,2 mm
[A]	Postazione di porta - postazione principale	50 m	100 m	100 m	100 m
[B]	Postazione di porta - adattatore per grandi distanze	100 m	150 m	200 m	200 m
[C]	Adattatore per grandi distanze - postazione principale	50 m	75 m	100 m	100 m

# MONTAGGIO

## JP-DA

### ① Rimozione dell'unità principale dal telaio di montaggio

Rimuovere l'unità principale. (Allentare le viti di bloccaggio).

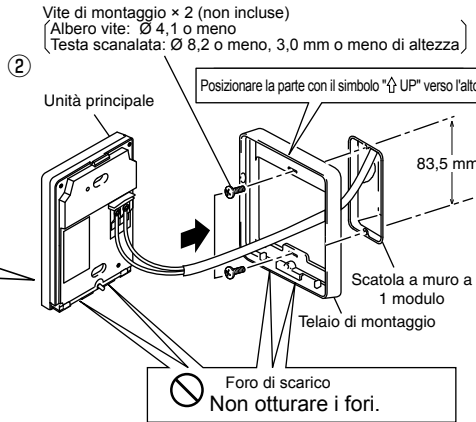
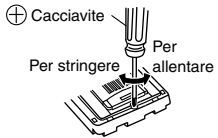

### ③ Montare l'unità principale sul telaio di montaggio, ed installare il pannello anteriore su di questa.

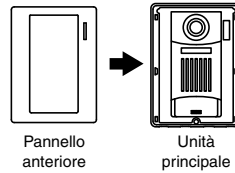

### Rimozione del pannello anteriore

<Superficie inferiore>

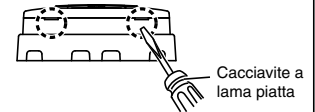

Servendosi di un cacciavite a lama piatta, staccare il pannello anteriore, facendo leva.

## JP-DV

Tasselli x 4 (non inclusi) (usare tasselli apposti in base alla misure delle viti di fissaggio)

(Il diametro e la profondità dei fori nella parete dipendono dai tasselli utilizzati con le viti di montaggio.)

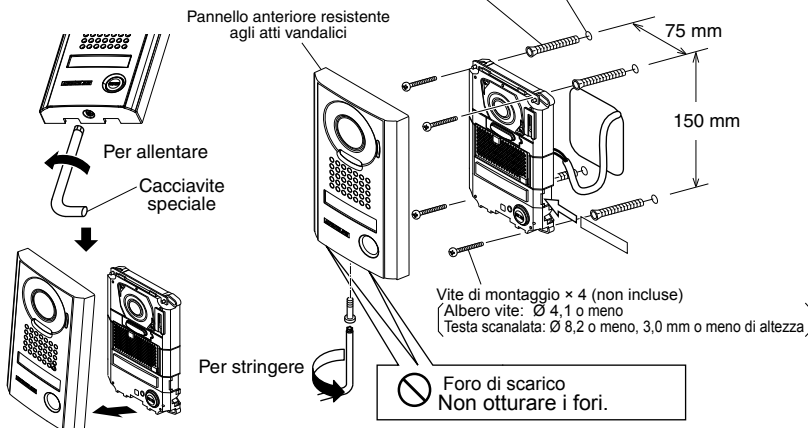

### Uso delle targhette trasparenti

#### Inserimento delle targhette trasparenti

- ① Rimuovere il pannello anteriore resistente agli atti vandalici.
- ② Staccare la pellicola protettiva dalla targhetta (sui due lati).
- ③ Scrivere sulla targhetta il nome dell'inquilino dell'abitazione corrispondente.
- ⚠ Assicurarsi di lasciare 25 mm di spazio sulla destra per l'inserimento della targhetta.
- ④ Inserire la targhetta trasparente completa del nome nell'apertura specificata (indicata nel diagramma con ←) come indicato sotto.

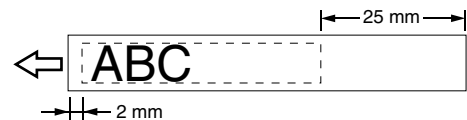
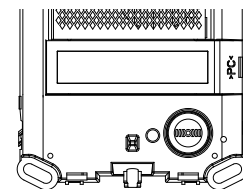

\* Rimuovere la pellicola protettiva dalla telecamera prima dell'uso.

## JP-DVF

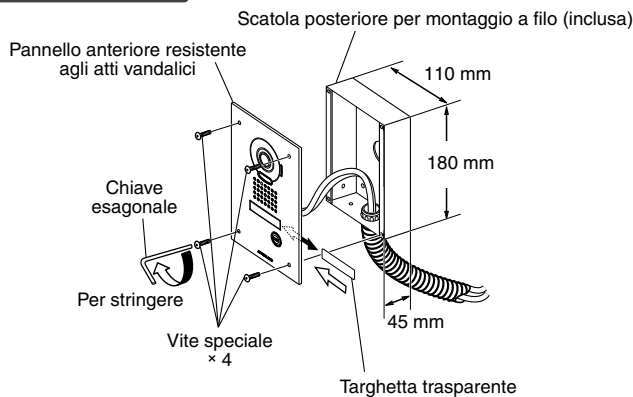

### Uso delle targhette trasparenti

#### Inserimento delle targhette trasparenti

- ① Rimuovere il pannello anteriore resistente agli atti vandalici dalla scatola posteriore per il montaggio a filo.
- ② Staccare la pellicola protettiva dalla targhetta (sui due lati).
- ③ Scrivere sulla targhetta il nome dell'inquilino dell'abitazione corrispondente.
- ⚠ Assicurarsi di lasciare 25 mm di spazio sulla destra per l'inserimento della targhetta.
- ④ Inserire la targhetta trasparente completa del nome nell'apertura specificata sul retro del pannello anteriore resistente agli atti vandalici (indicata con ← nel diagramma).

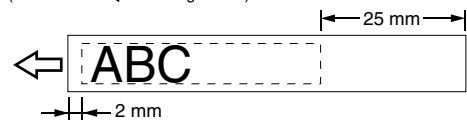

\* Rimuovere la pellicola protettiva dalla telecamera prima dell'uso.

## CABLAGGIO

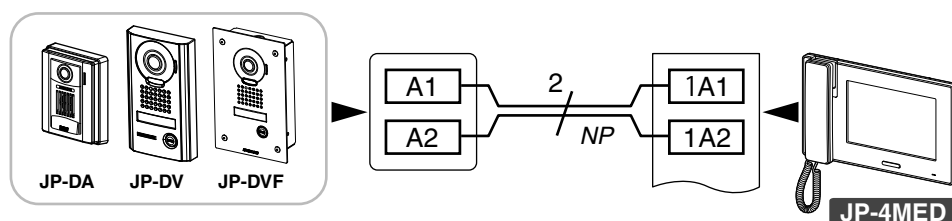

NP: Non polarizzato

## PRECAUZIONI TECNICHE

- La postazione videocitofonica esterna è resistente alle intemperie. Tuttavia, è bene non spruzzare direttamente sulla postazione getti d'acqua ad alta pressione. L'unità si potrebbe guastare.
- Pulizia:
  - Pulire le unità con un panno soffice e un detergente delicato. Non spruzzare il detergente direttamente sull'unità. Non utilizzare detersivi o panni abrasivi.
  - Togliere lo sporco dall'obiettivo delicatamente con un panno morbido. Osservare i seguenti passaggi per la manutenzione dell'obiettivo.
    - Fare attenzione a non graffiare l'obiettivo.
    - Non utilizzare solventi organici diversi dall'alcool isopropilico (IPA) e dal metanolo.
    - Non usare diluente, benzene, ecc. Ciò potrebbe provocare danni o decolorazione sulla superficie dell'unità.

## SPECIFICHE

Alimentazione	Fornita dalla postazione principale	
Temperatura di funzionamento	-10 - 60°C	
Telecamera	Semiconduttore ad ossido di metallo complementare (CMOS)	
Linee esploratrici	525 linee	
Illuminazione minima del soggetto	5 Lux ad una distanza di 50 cm	
Dimensioni	JP-DA	129 (A) x 97 (L) x 30,5 (P) (mm)
	JP-DV	173 (A) x 98 (L) x 27,1 (P) (mm)
	JP-DVF	209 (A) x 135 (L) x area esposta 5,6 (P) (mm)
	Scatola posteriore per montaggio a filo (JP-DVF)	180 (A) x 110 (L) x 45 (P) (mm)
Peso	JP-DA	Circa 170 g
	JP-DV	Circa 650 g
	JP-DVF	Circa 570 g
	Scatola posteriore per montaggio a filo (JP-DVF)	Circa 450 g

## WARRANTY

English

Aiphone warrants its products to be free from defects of material and workmanship under normal use and service for a period of two years after delivery to the ultimate user and will repair free of charge or replace at no charge, should it become defective upon which examination shall disclose to be defective and under warranty. Aiphone reserves unto itself the sole right to make the final decision whether there is a defect in materials and/or workmanship; and whether or not the product is within the warranty. This warranty shall not apply to any Aiphone product which has been subject to misuse, neglect, accident, power surge, or to use in violation of instructions furnished, nor extended to units which have been repaired or altered outside of the factory. This warranty does not cover batteries or damage caused by batteries used in connection with the unit. This warranty covers bench repairs only, and any repairs must be made at the shop or place designated in writing by Aiphone. This warranty is limited to the standard specifications listed in the operation manual. This warranty does not cover any supplementary function of a third party product that is added by users or suppliers. Please note that any damage or other issues caused by failure of function or interconnection with Aiphone products is also not covered by this warranty. Aiphone will not be responsible for any costs incurred involving on site service calls. Aiphone will not provide compensation for any loss or damage incurred by the breakdown or malfunction of its products during use, or for any consequent inconvenience or losses that may result.

The object area of  is the EU.

## GARANTIE

Français

Aiphone garantit que ses produits ne sont affectés d'aucun défaut de matière ni de fabrication, en cas d'utilisation normale et de réparations conformes, pendant une période de deux ans après la livraison à l'utilisateur final, et s'engage à effectuer gratuitement les réparations nécessaires ou à remplacer l'appareil gratuitement si celui-ci présente un défaut, à la condition que ce défaut soit bien confirmé lors de l'examen de l'appareil et que l'appareil soit toujours sous garantie. Aiphone se réserve le droit exclusif de décider s'il existe ou non un défaut de matière et/ou de fabrication et si l'appareil est ou non couvert par la garantie. Cette garantie ne s'applique pas à tout produit Aiphone qui a été l'objet d'une utilisation impropre, de négligence, d'un accident, d'une surtension ou qui a été utilisé en dépit des instructions fournies ; elle ne couvre pas non plus les appareils qui ont été réparés ou modifiés en dehors de l'usine. Cette garantie ne couvre pas les piles ni les dégâts infligés par les piles utilisées dans l'appareil. Cette garantie couvre exclusivement les réparations effectuées en atelier. Toute réparation doit être effectuée à l'atelier ou à l'endroit précisé par écrit par Aiphone. Cette garantie est limitée aux spécifications standard répertoriées dans le manuel d'utilisation. Cette garantie ne couvre pas les fonctions supplémentaires d'un produit tiers ajouté par les utilisateurs ou fournisseurs. Veuillez noter que les dommages ou autres problèmes causés par l'échec de fonction ou interconnexion avec les produits Aiphone ne sont pas non plus couverts par cette garantie. Aiphone décline toute responsabilité en cas de frais encourus pour les dépannages sur site. Aiphone n'indemniser pas le client en cas de pertes, de dommages ou de désagréments causés par une panne ou un dysfonctionnement d'un de ses produits lors de l'utilisation, ou pour toute perte ou tout problème qui peut en résulter.

La zone d'application de  est l'UE.

## GARANTÍA

Español

Aiphone garantiza que sus productos están libres de defectos de material y mano de obra, en uso y servicio normal, por un período de dos años después de la entrega final al último usuario y reparará sin costo, o reemplazará sin cargo, si llegara a resultar defectuoso, mediante una inspección que determine que efectivamente está con defecto y en garantía. Aiphone se reserva para sí la facultad única de tomar la decisión final para juzgar si existe una falla en materiales y/o mano de obra, y si el producto está o no cubierto por la garantía. Esta garantía no se aplicará a ningún producto Aiphone que haya sido sometido a maltrato, negligencia, accidente, sobrecarga de energía o que haya sido usado de manera diferente a las instrucciones proporcionadas, o bien por las equipoes que hayan sido reparadas o alteradas fuera de fábrica. Esta garantía no cubre baterías o daños causados por baterías usadas en conjunto con el equipo. La garantía cubre solo las reparaciones efectuadas en la mesa de trabajo y cualquier reparación debe ser efectuada en el taller o lugar designado por escrito por Aiphone. Esta garantía se limita a las especificaciones estándar indicadas en el manual de funcionamiento. Esta garantía no cubre ninguna función adicional de un producto de terceros que haya sido añadido por los usuarios o proveedores. Tenga en cuenta que los daños u otros problemas causados por un fallo de funcionamiento o por la interconexión con los productos de Aiphone tampoco están cubiertos por la garantía. Aiphone no se responsabilizará por costos incurridos en cualquier llamada de servicio al sitio mismo en que se presente el defecto. Aiphone no indemnizará por ninguna pérdida o daño en que se incurra debido a la avería o falla de sus productos durante su uso, ni por ningún inconveniente o pérdida que se produzca como consecuencia.

El área de objeto de  es la UE.

## GARANTIE

Nederlands

Aiphone waarborgt zijn producten tegen materiaal- en fabricagefouten bij normaal gebruik en onderhoud gedurende een periode van twee jaar na levering aan de eindgebruiker, en zal het product kosteloos herstellen of vervangen indien na onderzoek blijkt dat het toestel een defect heeft dat onder de waarborg valt. Aiphone behoudt zich het recht voor als enige definitief te bepalen of er al dan niet sprake is van een materiaal- en/of fabricagefout en of het product nog onder waarborg is. Deze waarborg geldt niet voor ieder Aiphoneproduct dat is blootgesteld aan verkeerd gebruik, verwaarlozing, een ongeval, stroomstoten, of verkeerde bediening en evenmin voor toestellen die buiten de fabriek zijn hersteld of aangepast. Deze waarborg geldt niet voor batterijen of schade veroorzaakt door batterijen die in het toestel zijn gebruikt. Deze waarborg dekt uitsluitend werkbankherstellingen en iedere herstelling moet worden uitgevoerd in een schriftelijk door Aiphone aangewezen winkel of werkplaats. Deze waarborg beperkt zich tot de standaardspecificaties die in de bedieningshandleiding staan vermeld. Deze waarborg beslaat geen enkele aanvullende functie van een product van een externe partij dat door gebruikers of leveranciers wordt toegevoegd. Gelieve op te merken dat schade of andere problemen die het gevolg zijn van storing bij gebruik of verbinding met producten anders dan die van Aiphone, eveneens niet door deze waarborg worden gedekt. Kosten die gepaard gaan met herstellingen ter plaatse kunnen niet worden verhaald op Aiphone. Er kan geen schadeloosstelling van Aiphone worden geëist voor enig verlies of schade als gevolg van een defect of storing tijdens het gebruik van zijn producten, of voor enig ongemak of verlies dat hieruit voortvloeit.

Het toepassingsgebied van  is de EU.

## GARANZIA

Italiano

Aiphone garantisce che i suoi prodotti sono privi di difetti nei materiali o nella lavorazione, in condizioni di utilizzo normali e per un periodo di due anni dalla consegna all'utente finale. Aiphone eseguirà la riparazione o la sostituzione gratuita del prodotto qualora tale prodotto risulti difettoso e la garanzia sia applicabile al difetto rilevato. Aiphone si riserva il diritto esclusivo di stabilire in via definitiva se sono presenti difetti nei materiali e/o nella lavorazione e se il prodotto è coperto dalla garanzia oppure no. La presente garanzia non è applicabile ad alcun prodotto Aiphone che sia stato sottoposto ad uso improprio, negligenza, incidente, sovraccorrente o che sia stato utilizzato in violazione alle istruzioni fornite, né può essere estesa alle unità che sono state riparate o manomesse al di fuori della fabbrica. Questa garanzia non copre le batterie né i danni causati dalle batterie usate in connessione con l'unità. Questa garanzia copre solo le riparazioni del prodotto consegnato presso il punto designato. Le eventuali riparazioni devono essere eseguite presso il punto vendita o il luogo designato per iscritto da Aiphone. Questa garanzia è limitata alle specifiche standard elencate nel manuale d'uso. Questa garanzia non copre le funzioni supplementari di prodotti di altre aziende aggiunti dagli utenti o dai fornitori. Eventuali danni o altri problemi causati da problemi di funzionamento o interconnessione con prodotti Aiphone non sono coperti da questa garanzia. Aiphone non potrà essere ritenuta responsabile di eventuali costi sostenuti in caso di chiamata per l'assistenza sul posto. Aiphone non offrirà alcun compenso per gli eventuali danni o perdite subiti a causa della rottura o del guasto dei suoi prodotti durante l'uso, o per qualsiasi disagio o perdita conseguente che si dovesse verificare.

L'area oggetto di  è l'UE

### FCC

This device complies with Part 15 of the FCC Rules. Operation is subject to the following two conditions: (1) this device may not cause harmful interference, and (2) this device must accept any interference received, including interference that may cause undesired operation.

This equipment has been tested and found to comply with the limits for a Class B digital device, pursuant to Part 15 of the FCC Rules. These limits are designed to provide reasonable protection against harmful interference in a residential installation. This equipment generates, uses, and can radiate radio frequency energy, and if not installed and used in accordance with the instructions, may cause harmful interference to radio communications.

However, there is no guarantee that interference will not occur in a particular installation. If this equipment does cause harmful interference to radio or television reception, which can be determined by turning the equipment off and on, the user is encouraged to try to correct the interference by one or more of the following measures:

- Reorient or relocate the receiving antenna
- Connect the equipment to an outlet on a circuit different from that to which the receiver is connected. Increase the separation between the equipment and receiver.
- Consult the dealer or an experienced radio/TV technician for help.

