



GT SERIEN

Flerbolig dørtelefoni

Quick Start Installation



ATTENTION:

Dette er en forkortet installationsmanual, der omhandler kabling og programmering af GT-serien. Den komplette installationsmanual leveres med GT-BC Bus Control Unit. Hvis du installerer et digitalt dørtelefonsystem, kan den komplette dokumentation og programmet til overførsel af navne og numre for hver beboer downloades fra www.aiphone.net.

Indholdsfortegnelse

System Kabling

Standard system kabling (audio only).....	3
Standard system kabling (audio/video).....	4
Udvidet system kabling.....	5
Kabling for tilvalgsfunktioner (bolig svarstationerne).....	5

Dip Switch opsætninger

Dip switch opsætninger (dør and service stationens ID opsætninger).....	6
Dip switch opsætninger (dørstationen).....	6

Programmering

Entering tenant information.....	7
Addressing tenants via dip switch method.....	8
Entering guard station and entrance station information.....	9
Transfer data to other guard stations and entrance stations.....	10
Uploading to stations via USB.....	11

GT Setup Tool for Android

Downloading settings.....	11 - 12
Editing settings.....	12
Uploading settings.....	13
Programming (addressing tenants via handshake method).....	14 - 15

GT-MCX Network Adaptor

Standard system wiring with GT-MCX.....	16
Dip switch settings (GT-MCX).....	17
System programming with GT-MCX.....	18
Programming (addressing tenants via dip switch method).....	19
Programming (entering guard station and entrance station information).....	20
Programming (transfer data to other guard/entrance stations).....	21
Programming (uploading to GT-MCX via LAN).....	22

DIP Switch ID Chart	23 - 24
----------------------------------	---------

STANDARD SYSTEM KABLING: KUN AUDIO

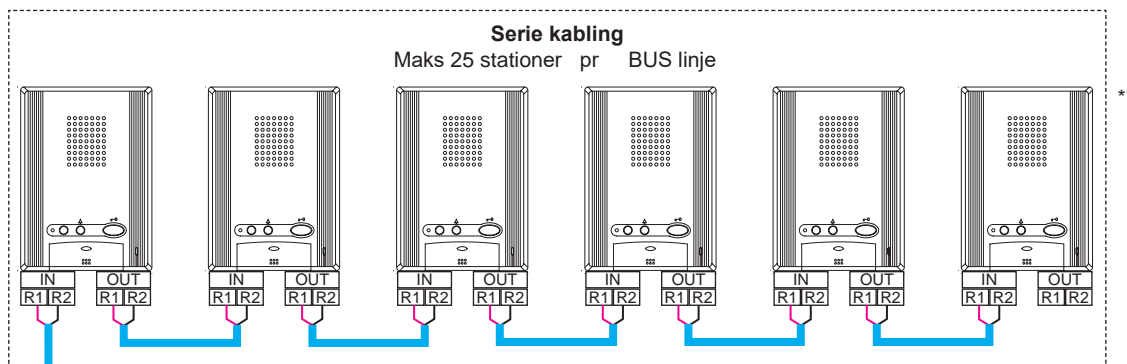

Maks. Kablings afstand fra fordelingspunktet til fjerneste svarstation 300 meter
 Maks. Samlede akumulerede ledningsafstand er 2500 meter.
 Se i installationsvejledningen til GT-serien for komplette kablings specifikationer.

Kabel TYPE

18AWG/0,9m2
 2 Leder. Massiv leder
 uden skærm med
 PE isolering

STRØMFORSYNING

PS24
 PS-2420D

PT
 Strømforsyning for
 EI-låsen

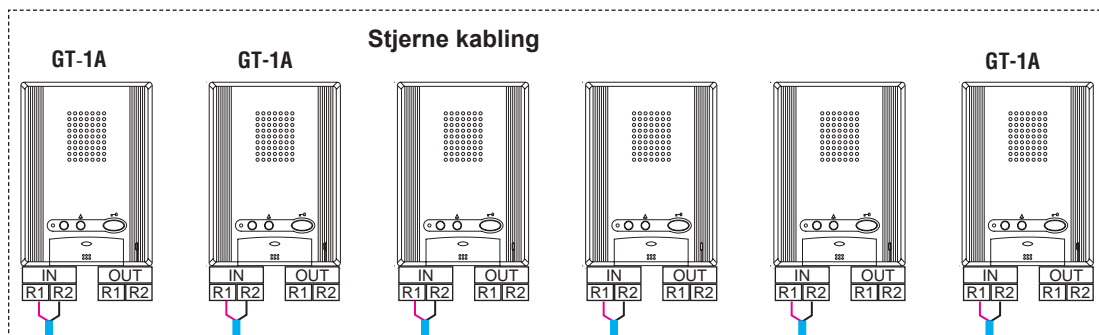

*DP

GT-BC

PS24

* Fordelings punkt:
 (GTW-DP) DIN monteret
 terminal for R1 / R2
 forbindelserne. (tilvalg!)

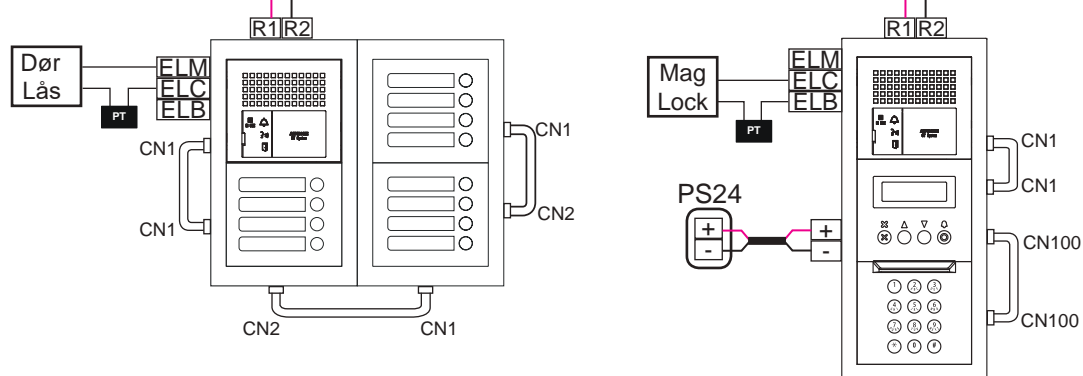

**Bolig svarstationen vist
 er GT-1A.

GT-1D
 svarstationen kan
 også benyttes med
 samme kablings
 prinsipper.

STANDARD SYSTEM WIRING: AUDIO / VIDEO

Serie kabling

Max. 25 stationer pr BUS linje. SW1 switch skal stå til A på sidste station.

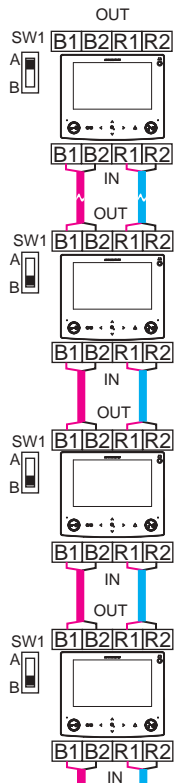

Stjerne kabling

Maks. 6 stk. GT-4Z'er pr. BUS linje. SW1-omskifteren skal indstilles til A på sidste GT-4Z i BUS linjen. Hver bolig svarstation forbundet til en GT-4Z, skal have SW1 switch indstillet til A.

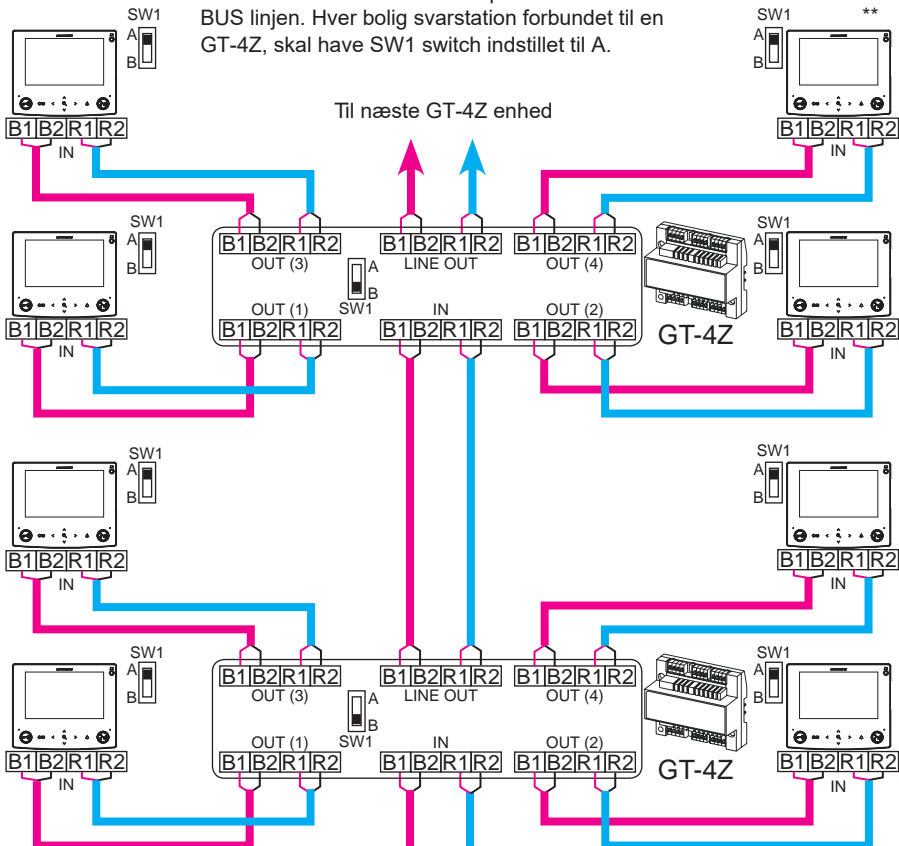

T-Tap Wiring Method

Max. of 25 stations per trunk with GT-1Z. SW1 switch must be set to A on each tenant station.

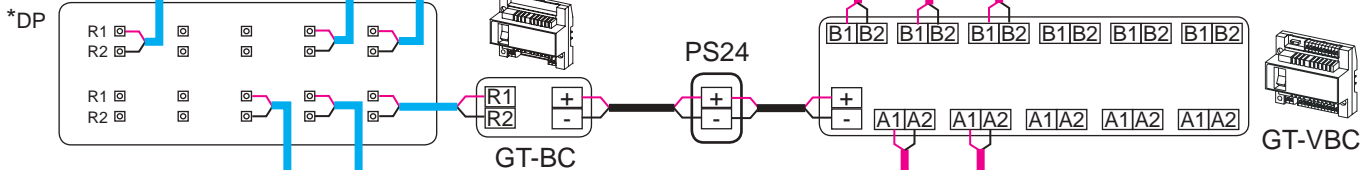
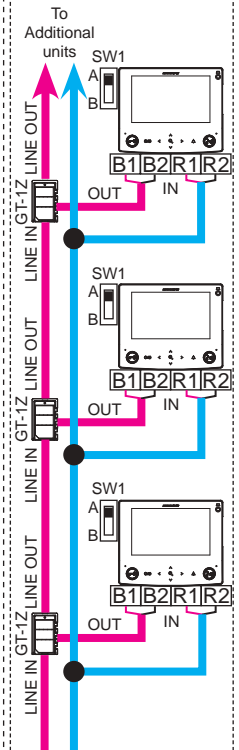

* Fordelings punkt: (GTW-DP) DIN monteret terminal for R1 / R2 forbindelserne. (tilvalg!)

Viste bolig svarstation er GT-1C7.

** GT-1M3 og GT-2C kan også benyttes med samme kablings principper.

Note: GT-2C kræver en separat PS-24 strømforsyning.

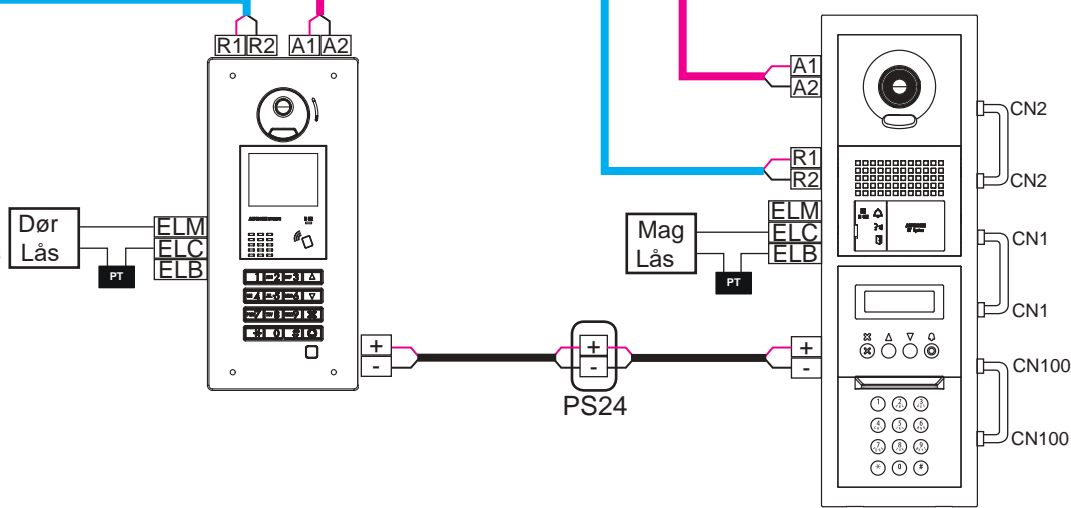

UDVIDET SYSTEM KABLING

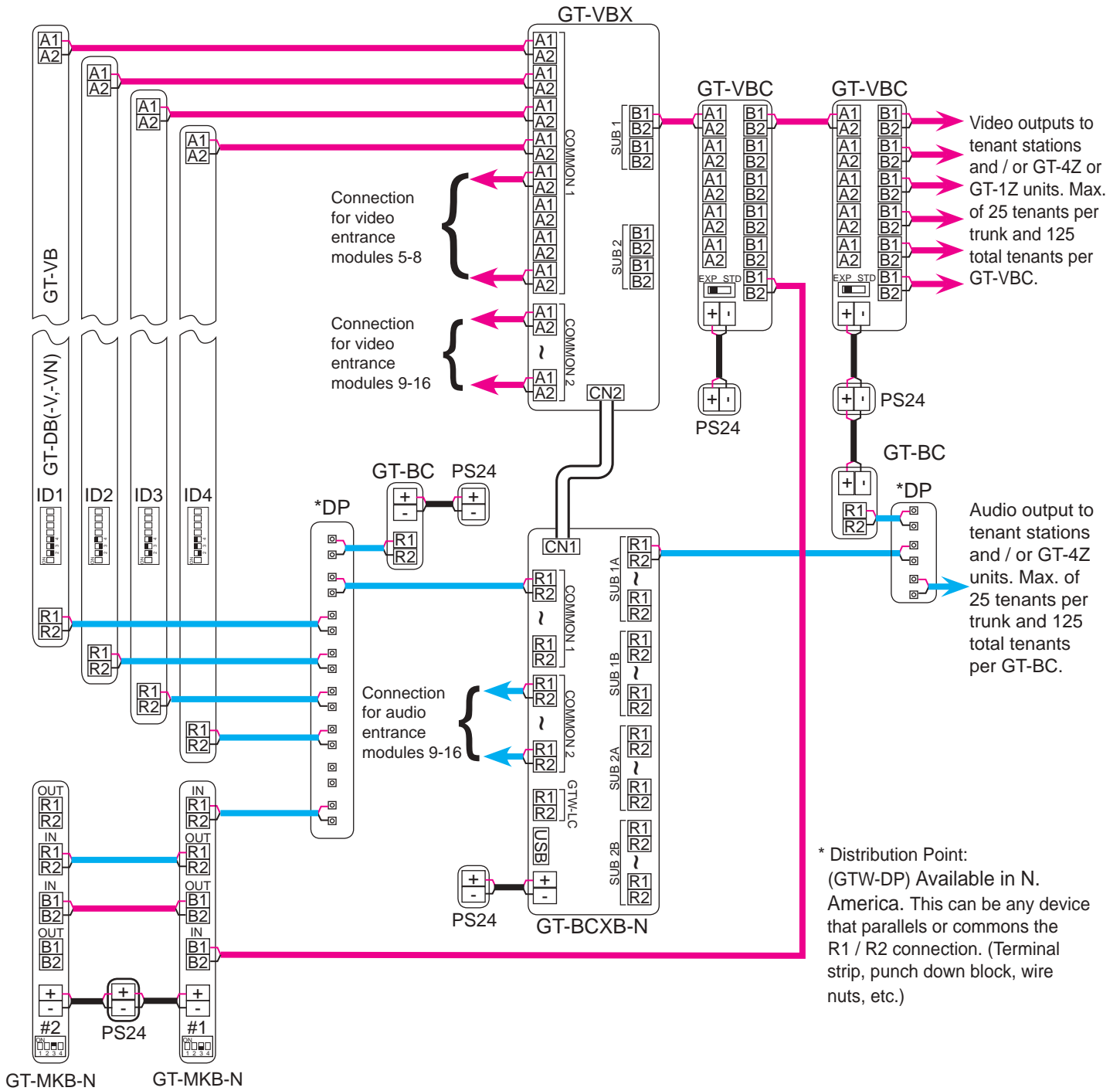

TILVALGSFUNKTIONER: For bolig svarstationerne

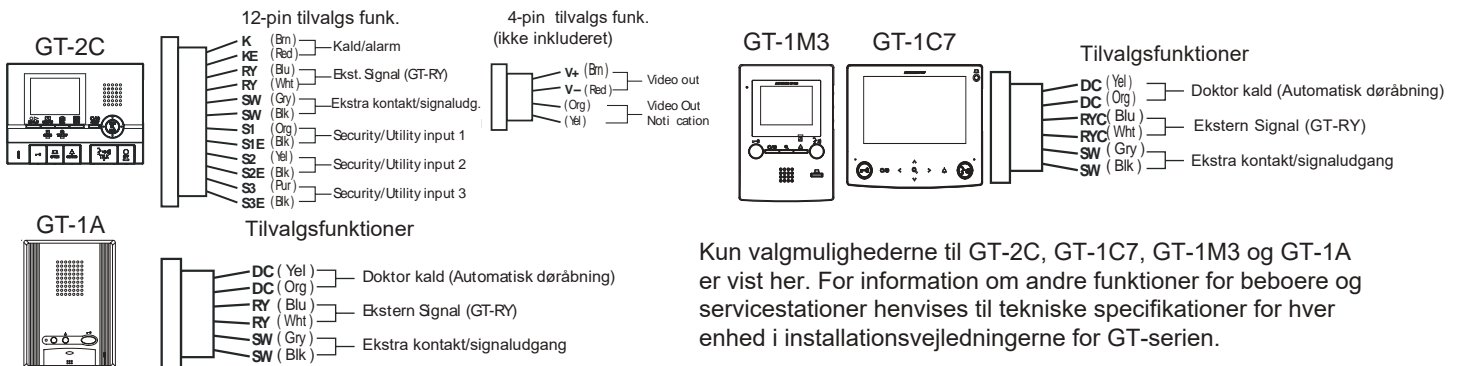

DIP SWITCH OPSÆTNING: DØRSTATIONER & SERVICE STATION ID OPSÆTNING

DØRSTATIONERNES ID Opsætning:

Benyt **SW2** på GT-DB(-V, -VN) moduler eller **SW1** på GT-DMB(-N, -LVN) dørstationer for unik ID opsætning til hver dør. Switchene 2 - 4 benyttes til denne opsætning.

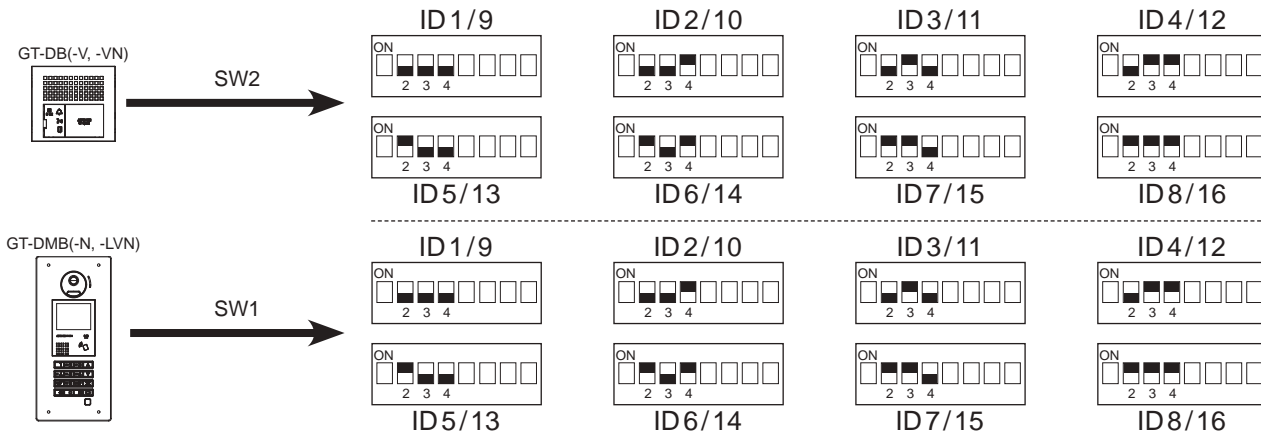

Service stationens ID Opsætning:

Benyt **SW2** på GT-MKB-N servicestationen for unik ID opsætning til hver servicestation. Switch 3 for denne opsætning.

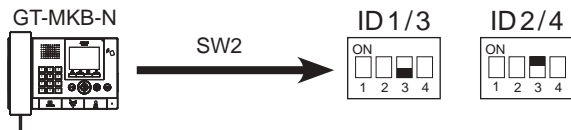

DIP SWITCH OPSÆTNING: DØRSTATIONER

NOTE:

Når du bruger GT-DMB (-N, -LVN), vil nedenstående indstillinger ske via tastaturet / displayet i programmeringsfunktionen. Se vejledningen til GT-serien.

Sørg for, at strømmen er fjernet fra systemet, inden der skiftes om på dip switche.

Vejledning i Sprog Indstilling:

Tale vejledning er som standard slukket (Ingen vejledning). Brug **SW3** på GT-DB (-V, -VN) modulet til at indstille det relevante sprog. Kun switchene 2, 3 og 4 bruges til denne indstilling.

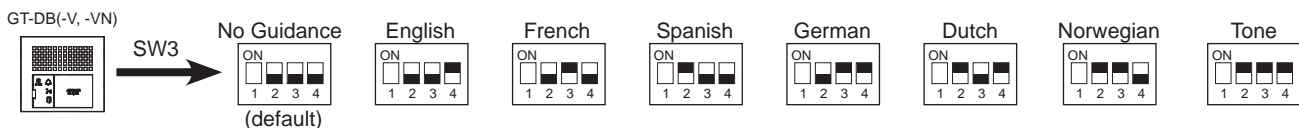

Monitorerings opsætning:

Brug switch 5 på SW2 i GT-DB (-V, -VN) modulet for at aktivere / deaktivere monitoreringen. Standard er "Overvågning ikke muligt." Aktivering vil gøre det muligt for beboere at "kalde op til" indgangen og overvåge dørområdet.



Kamera Visning:

Benyt switchene 3 & 4 i **SW1** på GT-VB modulet til at indstille kamera visningen. Fabriksindstilling til Zoom.

Zoom i 3s>>Vidvinkel: Billedet begynder at zoome, og efter 3 sekunder går det i vidvinkel visning.

Vidvinkel i 3s>>Zoom: Billedet starter i vidvinkel visning og efter 3 sekunder zoomer.

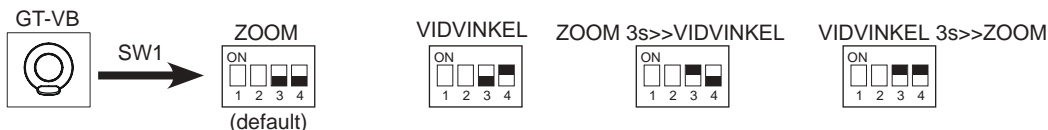

PROGRAMMERING: OPRETTELSE AF BEBOERINFORMATION

GT-DMB (N, -LVN), GT-MKB-N og modul digitale dørstationer skal programmeres med bolig oplysninger, før svarstationer kan adresseres. Bolig oplysninger kan indtastes ved hjælp af tastaturet eller ved hjælp af GT Setup Tool-softwaren.

Programmering af dørstationer med GT Setup Tool

Step 1: Åbn GT Setup Tool og klik på knappen Opret ny. Hvis du allerede er i programmet, under Fil, vælg Opret nyt (N).

Step 2: Forlad standardindstillingerne som vist, og klik derefter på **Next**

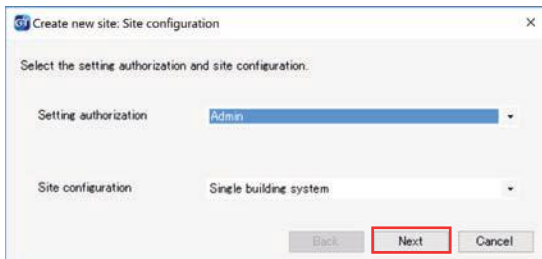

Step 3: Definer installationen og click **OK**.

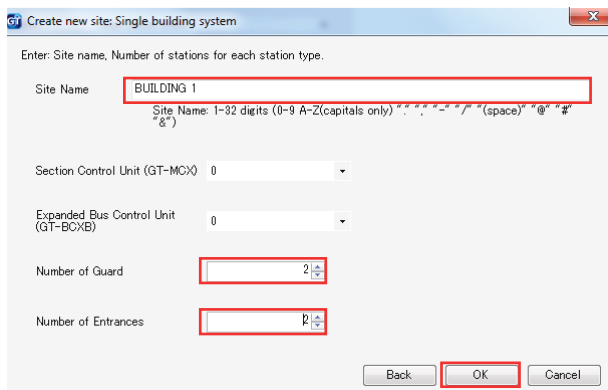

Step 4: Vælg indgang og opret bolig data

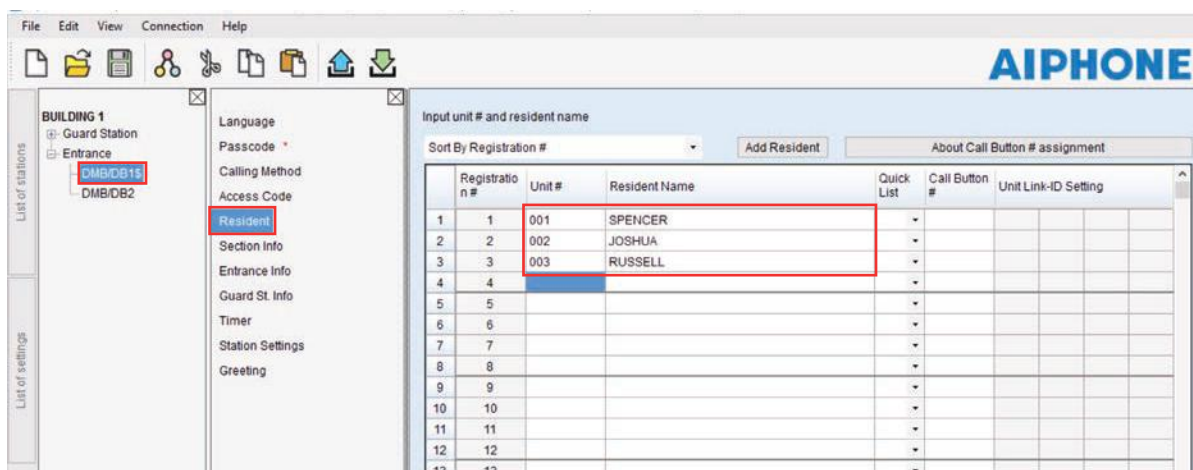

Step 5: Click Save , og **Yes**.

PROGRAMMERING: ADDRESSERING AF SVARSTATIONER VIA DIP SWITCH METODEN

Brug dip switch metoden til programmering vist nedenfor, når du installerer GT-1C7, GT-1M3 eller GT-2C. Når du installerer GT-1A eller GT-1D, skal du bruge "manuel" metoden vist på side 14-15. Hvis du bruger en blanding af stationer, der muliggør indstillinger for dip switch (GT-1C7, GT-1M3 og GT-2C) og stationer, der ikke gør det (GT-1A, GT-1D), anbefales det at programmere alle stationer ved hjælp af "manuel" metodeen.

Step 1: Opret en ID-opsætningstabel for bolig svarstationerne ved hjælp af et binært / SW2 Dip Switch-ID-kort. Skemaet nedenfor er for op til 48 svarstationer i et standard system. Se det fulde diagram på side 23 og 24 for dip switch-indstillingerne i et udvidet system.

Dip Switch	ID	Dip Switch	ID	Dip Switch	ID	Dip Switch	ID
□□□□□□□□	S1	□□□□□□□□	S13	□□□□□□□□	S25	□□□□□□□□	S37
□□□□□□□□	S2	□□□□□□□□	S14	□□□□□□□□	S26	□□□□□□□□	S38
□□□□□□□□	S3	□□□□□□□□	S15	□□□□□□□□	S27	□□□□□□□□	S39
□□□□□□□□	S4	□□□□□□□□	S16	□□□□□□□□	S28	□□□□□□□□	S40
□□□□□□□□	S5	□□□□□□□□	S17	□□□□□□□□	S29	□□□□□□□□	S41
□□□□□□□□	S6	□□□□□□□□	S18	□□□□□□□□	S30	□□□□□□□□	S42
□□□□□□□□	S7	□□□□□□□□	S19	□□□□□□□□	S31	□□□□□□□□	S43
□□□□□□□□	S8	□□□□□□□□	S20	□□□□□□□□	S32	□□□□□□□□	S44
□□□□□□□□	S9	□□□□□□□□	S21	□□□□□□□□	S33	□□□□□□□□	S45
□□□□□□□□	S10	□□□□□□□□	S22	□□□□□□□□	S34	□□□□□□□□	S46
□□□□□□□□	S11	□□□□□□□□	S23	□□□□□□□□	S35	□□□□□□□□	S47
□□□□□□□□	S12	□□□□□□□□	S24	□□□□□□□□	S36	□□□□□□□□	S48

Step 2: Indstil SW2 dip switchene, der findes på bagsiden af GT-1C7, GT-1M3 og GT-2C i henhold til opsætnings tabellen oprettet i forrige trin.

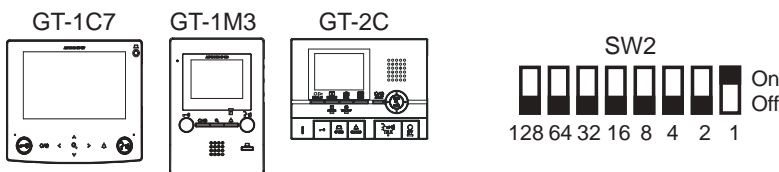

Step 3: Indtast id'et fra korrelationstabellen i trin 1 i enhedslink-id indstillingen for hver station.

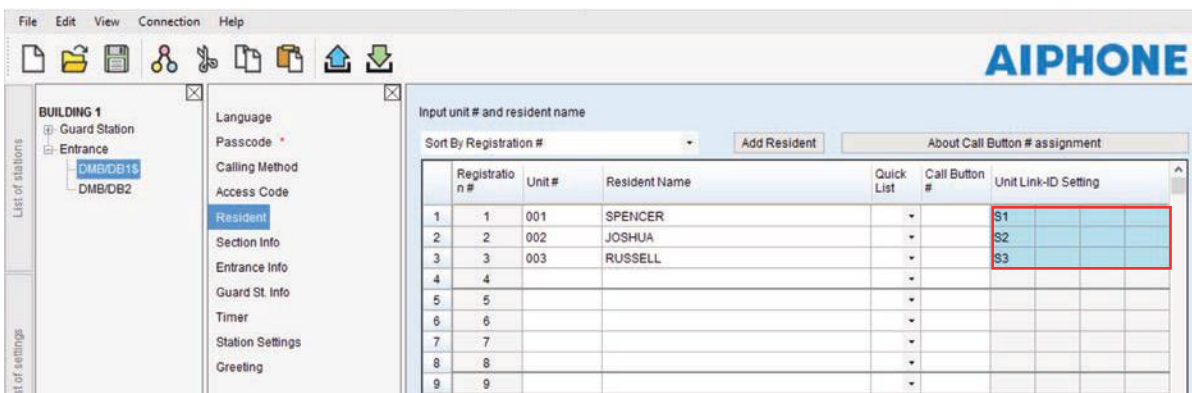

Step 4: Click Save , og **Yes**.

PROGRAMMING: ENTERING GUARD STATION AND ENTRANCE STATION INFORMATION

Programming Guard/Entrance Information

Step 1: Click the **+ Guard Station**, then select the guard station to program. Click **Entrance Info**, then enter 1 for the **Section ID**. Enter the **Entrance ID** (1-16), **Entrance #**, and **Entrance Name** (not required).

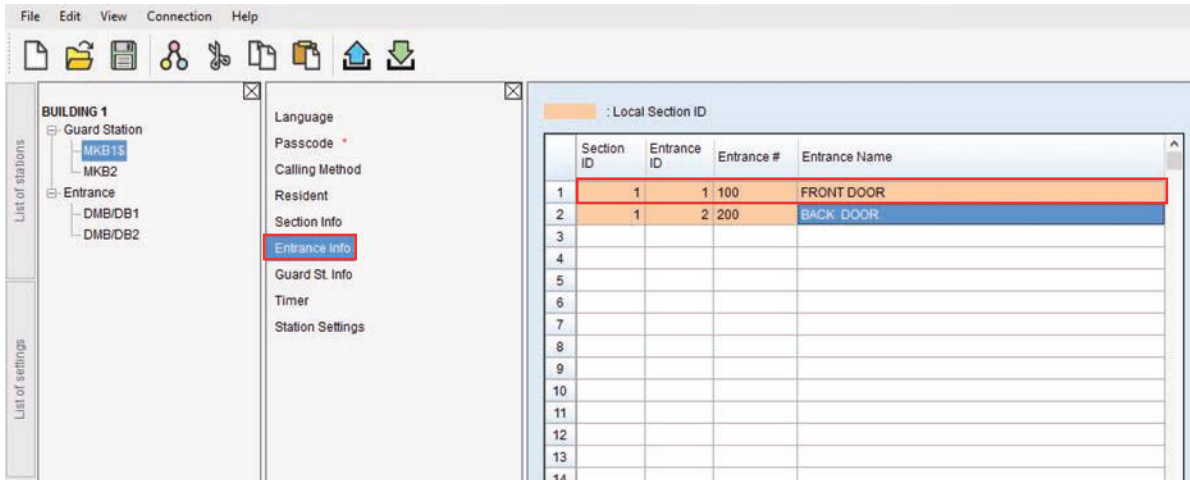

Step 2: Click **Guard St Info**, then enter 1 for the **Section ID**. Enter the **Guard St. ID** (1-2), **Guard St. #** and **Guard St Name** (not required) of the other guard station in the system.
Note: This step is not required if only using 1 guard station.

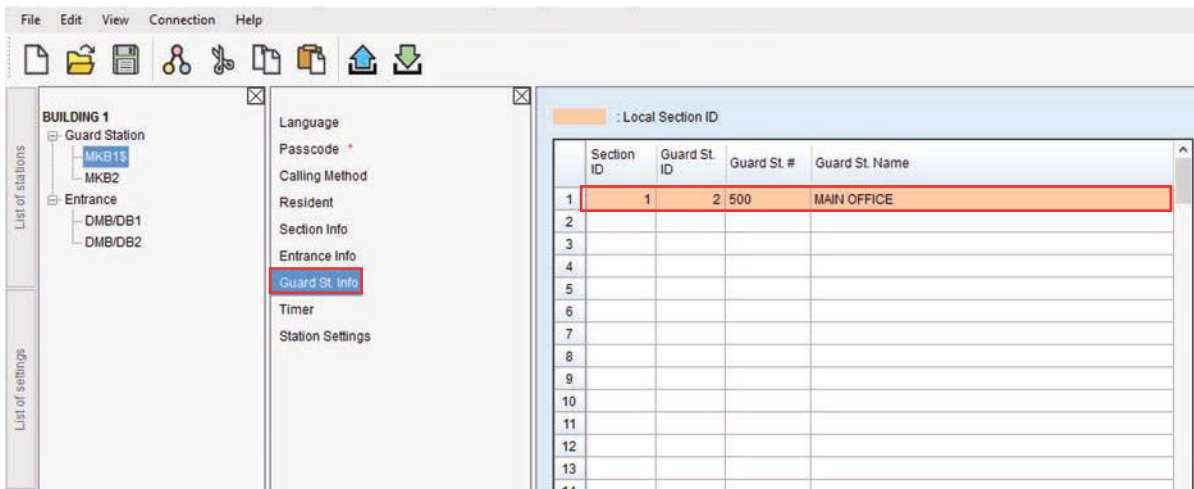

Step 3: Click the **+Entrance**, then select an entrance station. Repeat Step 2 to enter the Guard St Info for each entrance station. Since entrance stations cannot call other entrance stations, only guard station information will be entered for the entrance station.

Step 4: Click Save , and then **Yes**.



PROGRAMMING: TRANSFER DATA TO OTHER GUARD/ENTRANCE STATIONS

Compare and Merge (copy data to other devices in the system)

Step 1: Click **Compare and Merge Settings**  to copy data to other entrance and guard stations.

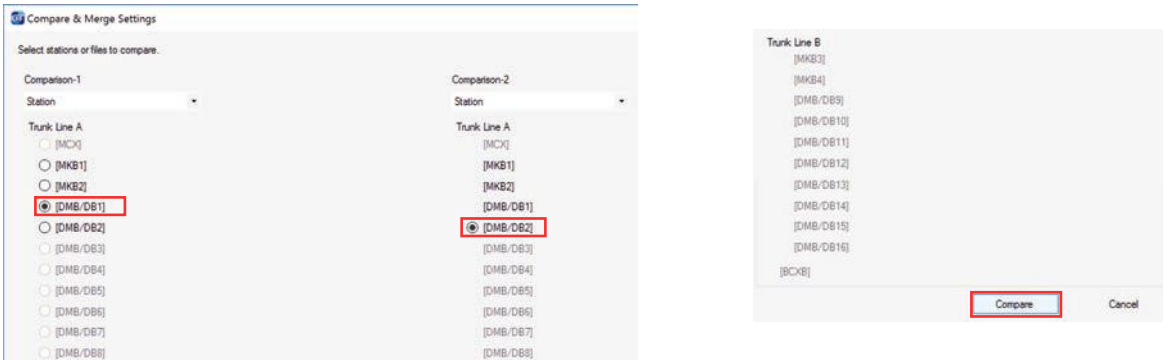
Step 2: In the **Comparison-1** column, select the entrance station/guard station radio button that was programmed. In the **Comparison-2** column, select the desired entrance station/guard station that data is to be copied to. Click **Compare**.



Step 3: Click **Resident**, then click  /  to copy the data to the new station. Click **Yes** on the **Do you want to overwrite all of the data?** popup. Click **Update**. Repeat process to copy Entrance Info and Guard Info. Click Exit when done. Repeat till the Resident information has been copied to all desired stations.

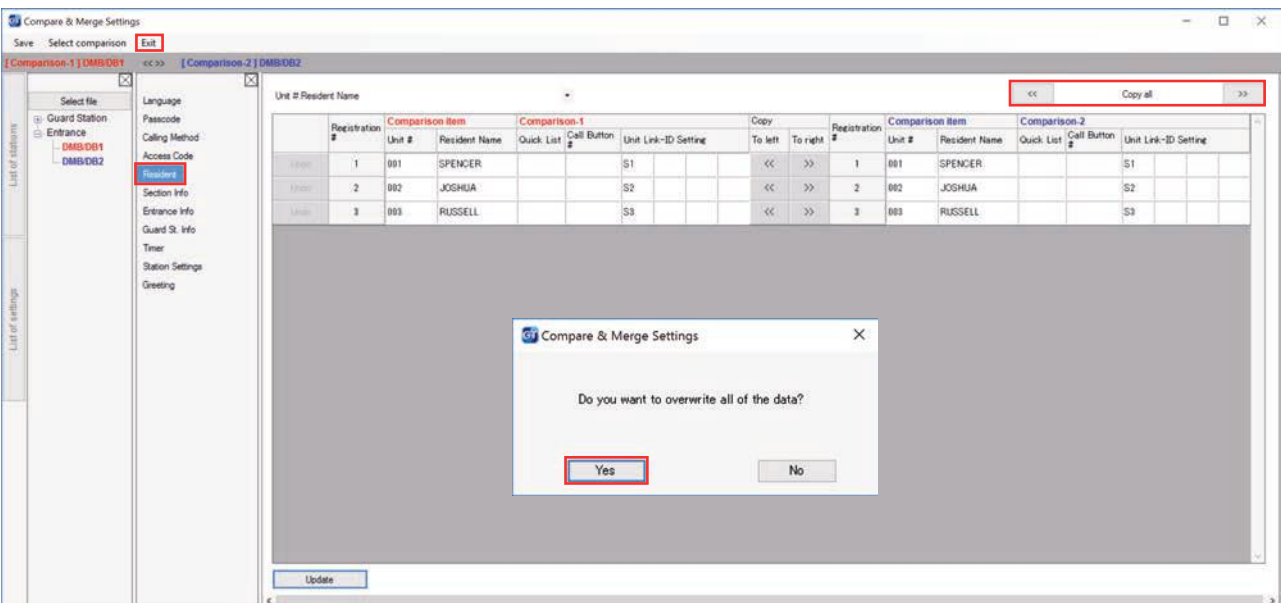

Step 4: Click **Save** , and then **Yes**.

PROGRAMMING: UPLOADING TO STATIONS VIA USB

Step 1: Click Upload .

Step 2: From the Upload (PC -> Station) menu, select the USB radio button. Select the desired device's radio button and click **OK**.

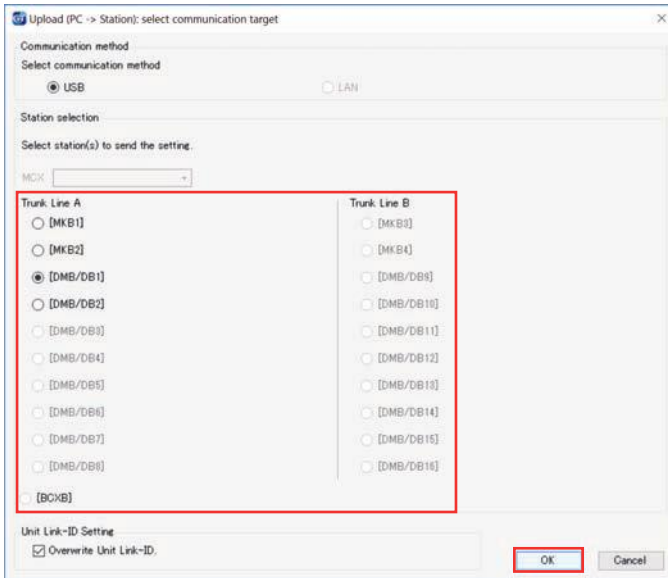

Step 3: Repeat for all stations.

GT SETUP TOOL FOR ANDROID

The Aiphone GT Setup Tool for Android app can be used to create and upload setting files to the GT-DMB(-N, -LVN) and GT-DB-VN entrance stations as well as the GT-MKB-N video guard station. It is recommended to use the GT Support Tool for Windows for the initial setting file creation and loading to the stations, then use the app for downloading and editing the setting file when changes need to be made. The following sections will cover how the app can be used for downloading and editing the setting file, then uploading. For complete information on using the app for programming, refer to the GT SYSTEM SETTING MANUAL/Aiphone GT Setup Tool for Android.

GT SETUP TOOL FOR ANDROID: DOWNLOADING SETTINGS

Step 1

Open the Aiphone GT Setup Tool for Android and tap **DOWNLOAD SETTING BY NFC**.

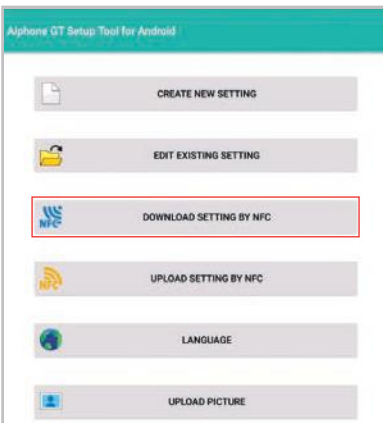

Step 2

Tap the appropriate authorization level and then tap **OK**.

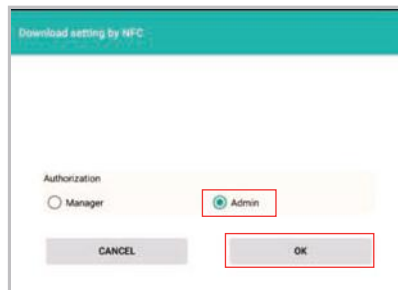

Step 3

Enter the appropriate passcode (default: Admin *1111, Manager #2222). Ensure that Upload Unit Link-ID settings is checked, then tap **OK**.

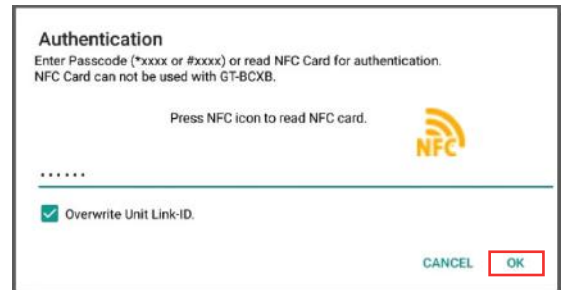

GT SETUP TOOL FOR ANDROID: DOWNLOADING SETTINGS *(continued)*

Step 4

Hold the Android device to the target station to download the settings.

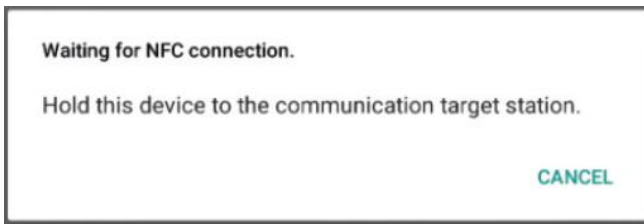

Step 5

The settings will begin to download to the Android device. Continue holding device to station until complete.

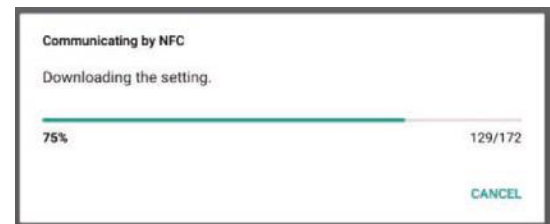

Step 6

A confirmation message will appear on the Android device if the download was successful.

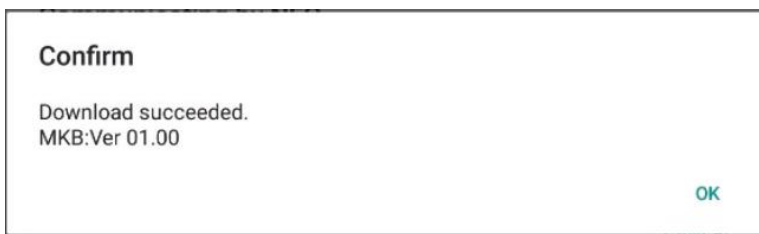

GT SETUP TOOL FOR ANDROID: EDITING SETTINGS

Step 1

Make the necessary edits to the downloaded setting file.

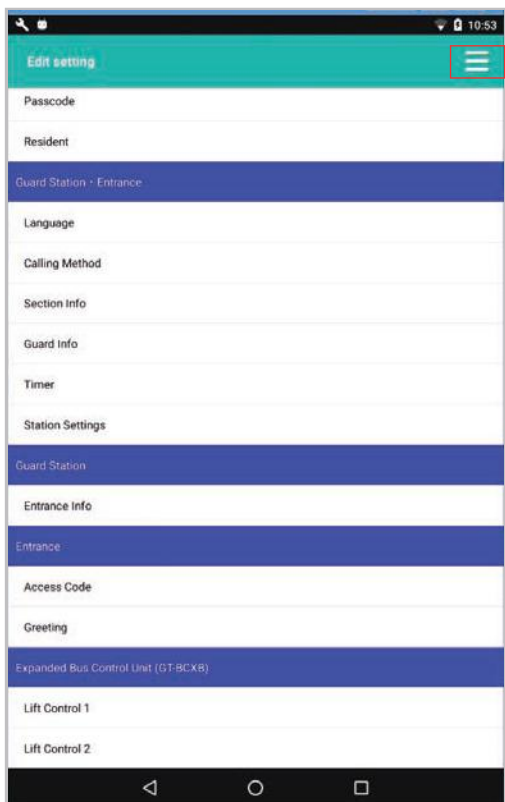

Step 2

Tap the menu button, then tap Save.



Step 3

Enter a file name (i.e. Job Name) and tap OK.

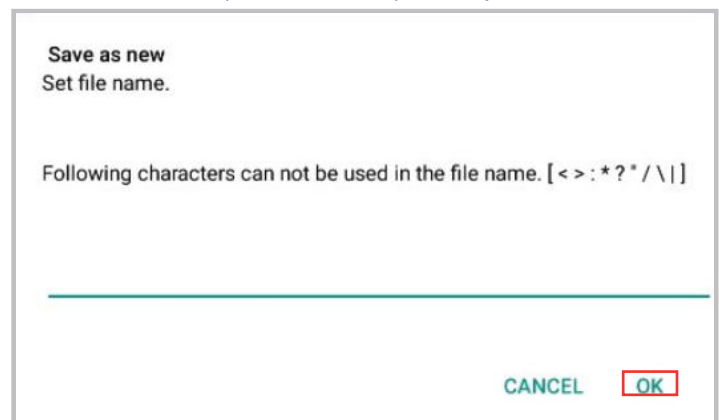

GT SETUP TOOL FOR ANDROID: UPLOADING SETTINGS

Step 1

Tap UPLOAD SETTING BY NFC.

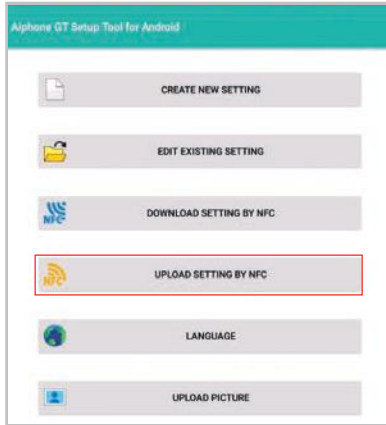

Step 2

Select the file to upload, tap the appropriate authorization level, then tap OK.

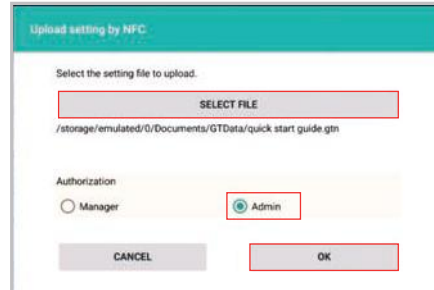

Step 3

Enter the appropriate passcode (default: Admin *1111, Manager #2222). Ensure that Upload Unit Link-ID settings is checked, then tap OK.

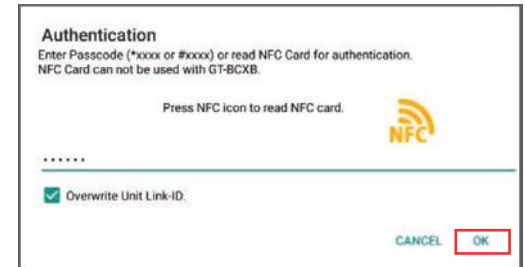

Step 4

Hold the Android device to the target station to upload the settings.

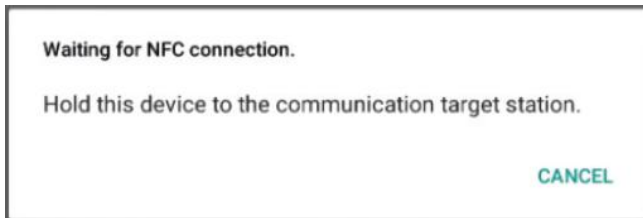

Step 5

The settings will begin to upload to the Android device. Continue holding device to station until complete.

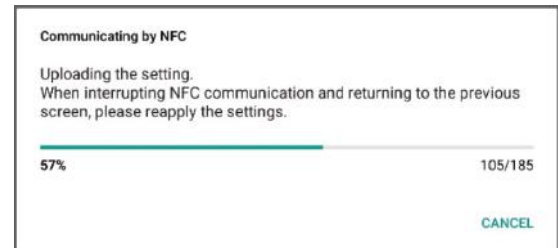

Step 6

A confirmation message will appear on the Android device if the upload was successful.

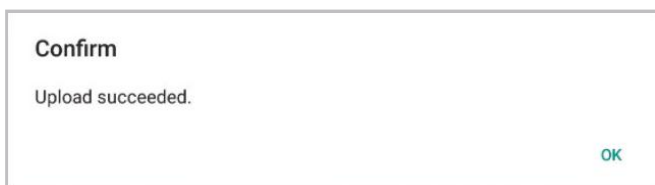

PROGRAMMING

Indtast id'et fra korrelationstabellen i trin 1 i enhedslink-idindstillingen for hver station.



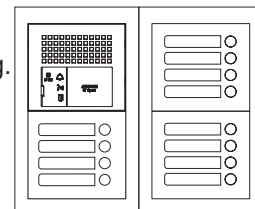

PROGRAMMERING: VIA DIREKTE VALG METODEN

Direkte valg / Opkaldstryk Adressering via Dørstationen

- Step 1:** For at komme ind i programmeringsfunktionen skal du bruge en lille skruetrækker til at aktivere knappen under gummiklappen på forsiden af talemodul GT-DB (-V, -VN). Det gule LED vil begynde at blinke og forblive konstant tændt. Når lampen er tændt, er indgangspanelet i programmeringsfunktion.
- Step 2:** På en bolig svarstation skal du trykke og slippe **TALK**-knappen eller løfte håndsættet for at etablere kommunikation med dørstationen der er i programmeringsfunktion.
- Step 3:** Tryk og slip det ønskede opkaldstryk på dørstationen for at tildele trykket til bolig svarstationen der er aktiv. En blip tone vil høres og programmeringen er udført for denne bolig.
Tryk og hold ikke på opkaldstasten, da hvis du gør det, slettes hukommelsen til denne bolig.
- Step 4:** Sluk svarstation (GT-1A / GT-1C7 / GT-1M3: Tryk **TALK** igen, GT-2C: Tryk **OFF**).
- Step 5:** Gentag trin 2-4 for de resterende bolig svarstationer.
- Step 6:** For at afslutte programmeringen skal du trykke på knappen under gummihætten på GT-DB (-V, -VN) lydmodul igen, og den gule LED slukker. Systemet er nu klar til brug.



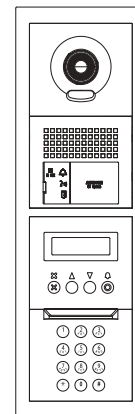

GT Digital Display Entrance Station Addressing

- Step 1:** Using the GT Support Tool for Windows, upload the program file to the GT-DB(-V, -VN) with the USB cable provided. Click  then select the station to upload to and click **OK**.
- Step 2:** To enter programming, use a small screwdriver to push and release button under the rubber cap on the front of the GT-DB(-V, -VN) audio module. The amber LED will begin flashing, then remain steadily lit. Once lit, the entrance station is in programming mode. The LCD will show "CONNECTING" while in programming mode.
- Step 3:** At a tenant station, push and release the **TALK** button or pick up the handset to establish communication with the entrance station in programming mode.
- Step 4:** Scroll to the station number to be programmed or manually enter the number on the keypad. When the tenant station number is displayed, push and release the **Bell** button  to assign the address to the tenant station that is active. A blip tone will be heard.
Do not press and hold the Bell button as doing so will clear the memory for this number.
- Step 5:** Turn off or hang up tenant station (GT-1A/GT-1C7/GT-1M3: Press **TALK** again, GT-2C: Press **OFF**).
- Step 6:** Repeat steps 3-5 for remaining tenant stations.
- Step 7:** To exit programming, push the button under the rubber cap on the GT-DB(-V, -VN) audio module again and the amber LED will turn off. The system is now ready for use.
- Step 8:** Download the program file to the GT Support Tool from the GT-DB(-V, -VN) audio module with the USB cable provided. Click  then select the station to download from and click **OK**.
- Step 9:** Click  to save the file to the computer.





PROGRAMMING: ADDRESSING TENANTS VIA HANDSHAKE METHOD *(continued)*

GT-DMB-N(-LVN) Entrance Station Addressing

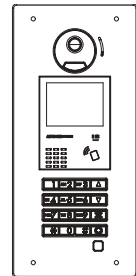
- Step 1:** Using the GT Support Tool for Windows, upload the program file to the GT-DMB-N(-LVN) with the USB cable provided. Click  then select the station to upload to and click **OK**.
- Step 2 :** While in standby mode, enter # plus the Admin ID code (default is *1111). Re-enter ID code.
- Step 3:** Use the up / down arrows and scroll to **PROGRAMMING**. Push the **Bell** button  twice to enter programming mode. The amber LED will begin flashing, then remain steadily lit. Once lit, the entry panel is in programming mode. The LCD will show "CONNECTING" while in programming mode.
- Step 4:** At a tenant station, push and release the **TALK** button or pick up the handset to establish communication with the entrance station in programming mode.
- Step 5:** Scroll to the station number to be programmed or manually enter the number on the keypad. When the tenant station number is displayed, push and release the **Bell** button  to assign the address to the tenant station that is active. A blip tone will be heard.



Do not press and hold the Bell button as doing so will clear the memory for this number.



- Step 6:** Turn off or hang up tenant station (GT-1A/GT-1C7/GT-1M3: Press **TALK** again, GT-2C: Press **OFF**).
- Step 7:** Repeat steps 4-6 for the remaining tenant stations.
- Step 8:** To exit programming, press the "**X**" button twice on the panel to return to the main menu (the amber LED will turn off). Scroll to **QUIT** and press the **Bell** button . The system is now ready for use.
- Step 9:** Download the program file to the GT Support Tool from the GT-DMB-N(-LVN) with the USB cable provided. Click  then select the station to download from and click **OK**.
- Step 10:** Click  to save the file to the computer.

GT-MKB-N Video Guard Station Addressing

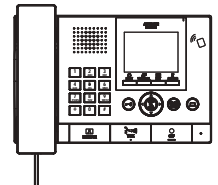
- Step 1:** Using the GT Support Tool for Windows, upload the program file to the GT-MKB-N with the USB cable provided. Click  then select the station to upload to and click **OK**.
- Step 2:** While in standby mode, press Setting. Scroll down to **ADVANCED SETTINGS** and press the Zoom/Wide button.
- Step 3:** Use the up/down arrows and scroll to **PROGRAM MODE**. Press the Zoom/Wide button. Enter the passcode (*1111). Re-enter the passcode again.
- Step 4:** Scroll to **PROGRAMMING** and select **PROGRAMMING** again from the next screen.
- Step 5:** The screen will show **CONNECTING**. When the orange LED on the unit remains steadily lit, the unit will be in programming mode.
- Step 6:** At a tenant station, push and release the **TALK** button or pick up the handset to establish communication with the GT-MKB-N in programming mode.
- Step 7:** Scroll to the station number to be programmed or manually enter the number on the keypad. When the tenant station number is displayed, push and release the **Zoom/Wide** button to assign the address to the tenant station that is active. A blip tone will be heard.



Do not press and hold the Zoom/Wide button as doing so will clear the memory for this number.

- Step 8:** Turn off or hang up tenant station (GT-1A/GT-1C7/GT-1M3: Press **TALK** again, GT-2C: Press **OFF**).
- Step 9:** Repeat steps 6-8 for the remaining tenant stations.
- Step 10:** To exit programming, press the **SETTING** button twice to return to the main menu. Scroll to **QUIT** and press the Zoom/Wide button to return to standby. The system is now ready for use.
- Step 11:** Download the program file to the GT Support Tool from the GT-DMB-N with the USB cable provided. Click  then select the station to download from and click **OK**.
- Step 12:** Click  to save the file to the computer.

STANDARD SYSTEM WIRING WITH GT-MCX

Including the GT-MCX will reduce the total allowable entrance stations from 5 to 4 and the total allowable guard/concierge stations from 2 to 1, but will allow multiple systems to be connected.

Loop Wiring Method

Max. of 25 stations per loop. SW1 switch must be set to A on last monitor in the wire loop.

To additional units

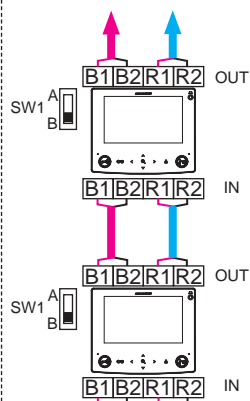

Homerun Wiring Method

Max. of 6 GT-4Zs per loop. SW1 switch must be set to A on last GT-4Z in the wire loop. Each tenant station homeruns to a GT-4Z and its SW1 switch must be set to A. The GT-1Z (not shown) 1 zone divider can be used to T-Tap the video wire to a tenant station.

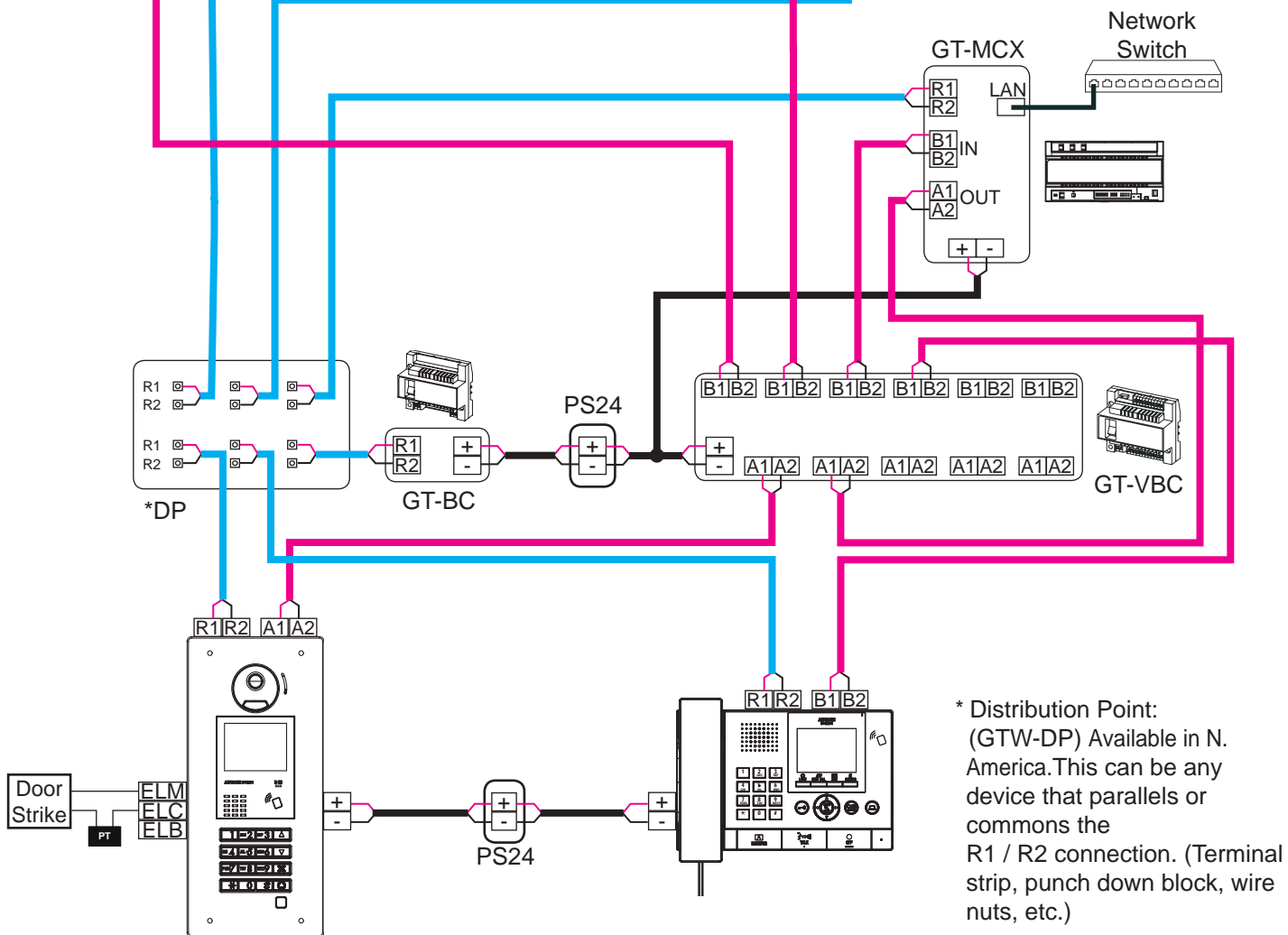
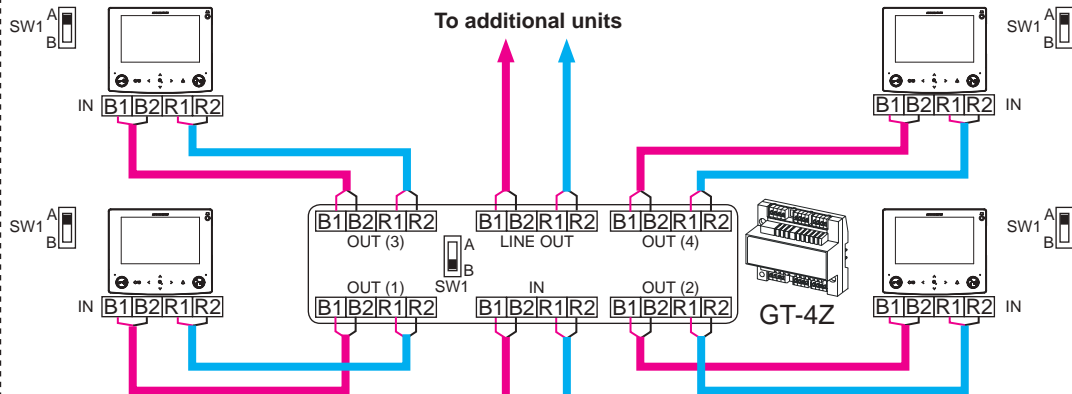

* Distribution Point: (GTW-DP) Available in N. America. This can be any device that parallels or commons the R1 / R2 connection. (Terminal strip, punch down block, wire nuts, etc.)

GT-MCX: Network Adaptor

The GT-MCX connects a GT system to a network, allowing multiple GT systems to be tied together. Each system now becomes known as a section and requires its own GT-MCX. There are two types of sections, the tenant section and the main section. A tenant section can contain tenant stations, entry stations, and guard stations. A main section can contain entry stations and guard stations.

The following steps in this guide cover programming for a single system with the GT-MCX network adaptor. If programming a multi-building system, please refer to the **GT MULTI BUILDING SETTING MANUAL** (sections 4-6) for complete programming instructions.

DIP SWITCH SETTINGS: GT-MCX

Each GT-MCX must be given a unique section ID and IP address by setting its SW2 dip switch. The default IP address of the GT-MCX is 192.168.1.51 for ID1 (192.168.1.50 + ID number).

Step 1: Keep the power switch OFF. Set SW3 dip switch 1 to ON (turns off DHCP).



Step 2: Set the SW2 dip switches 2-6 to the desired section ID (see chart below). The default IP address of the GT-MCX will be 192.168.1.51 for ID1 (192.168.1.50 + ID number).

GT-MCX

← SW3

← SW2

← ON/OFF

ID's 1-24: Tenant Sections

Dip Switch	ID	Dip Switch	ID	Dip Switch	ID	Dip Switch	ID
	1		2		3		4
	5		6		7		8
	9		10		11		12
	13		14		15		16
	17		18		19		20
	21		22		23		24

ID's 25-32: Main Sections

Dip Switch	ID	Dip Switch	ID	Dip Switch	ID	Dip Switch	ID
	25		26		27		28
	29		30		31		32

Step 3: Set Power switch to ON.

SYSTEM PROGRAMMING WITH GT-MCX

The GT-MCX, GT-DMB(-N, -LVN), GT-MKB-N, and modular digital entrance stations must be programmed with the resident's information before tenant stations can be addressed. The resident's information can be entered using the keypad or by using the GT Setup Tool software.

Programming entrance stations using the GT Setup Tool for Windows

Step 1: Open the GT Setup Tool and click the **Create new site** radio button. If already in the program under **File**, select **Create new site(N)**.

Step 2: Leave the standard options as shown, then click **Next**.

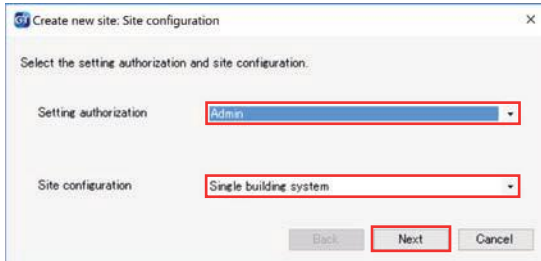

Step 3: Enter a **Site Name** and indicate if **GT-MCX** or **GT-BCXB** will be used. From the drop down menu, select the **Number of Guards** and the **Number of Entrances**. The GT-MCX will take the place of 1 Guard St. and 1 Entrance Station.

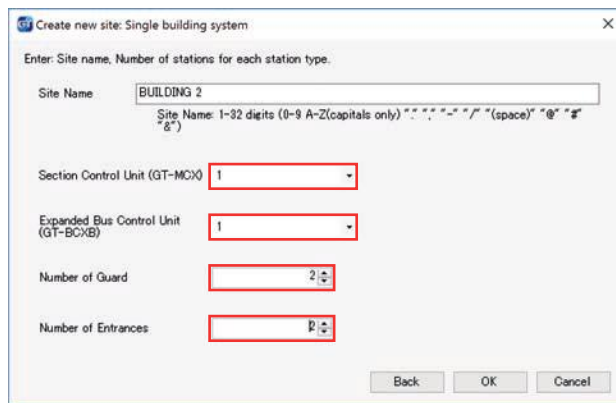

Step 4: Click the **+ MCX** and then click **Resident**. Enter a **Unit #** (required) and a **Resident Name** (not required). If using the GT-SW, enter the **Call Button #**.

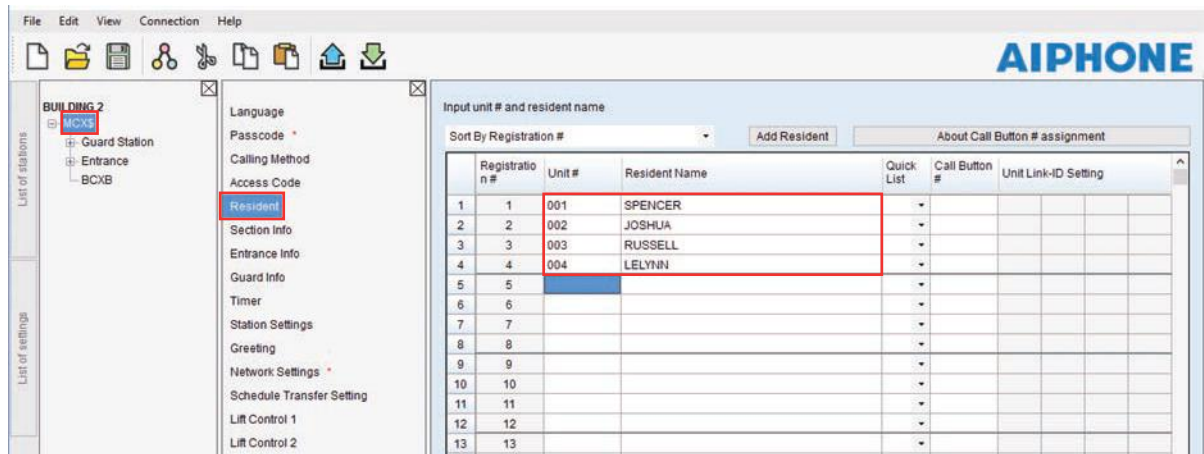

Step 5: Click **Save** , and then **Yes**.

PROGRAMMING: ADDRESSING TENANTS VIA DIP SWITCH METHOD

Step 1: Create an ID correlation table for the tenant stations using the binary / SW2 Dip Switch - ID chart. The chart below is for the first 48 stations in a non-expanded or expanded system. Refer to the full chart on pages 23 and 24 for the dip switch settings for an expanded system.

Dip Switch	ID	Dip Switch	ID	Dip Switch	ID	Dip Switch	ID
□□□□□□□□	S1/A1	□□□□□□□□	S13/A13	□□□□□□□□	S25/A25	□□□□□□□□	S37/A37
□□□□□□□□	S2/A2	□□□□□□□□	S14/A14	□□□□□□□□	S26/A26	□□□□□□□□	S38/A38
□□□□□□□□	S3/A3	□□□□□□□□	S15/A15	□□□□□□□□	S27/A27	□□□□□□□□	S39/A39
□□□□□□□□	S4/A4	□□□□□□□□	S16/A16	□□□□□□□□	S28/A28	□□□□□□□□	S40/A40
□□□□□□□□	S5/A5	□□□□□□□□	S17/A17	□□□□□□□□	S29/A29	□□□□□□□□	S41/A41
□□□□□□□□	S6/A6	□□□□□□□□	S18/A18	□□□□□□□□	S30/A30	□□□□□□□□	S42/A42
□□□□□□□□	S7/A7	□□□□□□□□	S19/A19	□□□□□□□□	S31/A31	□□□□□□□□	S43/A43
□□□□□□□□	S8/A8	□□□□□□□□	S20/A20	□□□□□□□□	S32/A32	□□□□□□□□	S44/A44
□□□□□□□□	S9/A9	□□□□□□□□	S21/A21	□□□□□□□□	S33/A33	□□□□□□□□	S45/A45
□□□□□□□□	S10/A10	□□□□□□□□	S22/A22	□□□□□□□□	S34/A34	□□□□□□□□	S46/A46
□□□□□□□□	S11/A11	□□□□□□□□	S23/A23	□□□□□□□□	S35/A35	□□□□□□□□	S47/A47
□□□□□□□□	S12/A12	□□□□□□□□	S24/A24	□□□□□□□□	S36/A36	□□□□□□□□	S48/A48

Step 2: Set the SW2 dip switches found on the back of the GT-1C7, GT-1M3, and GT-2C according to the correlation table created in the previous step.

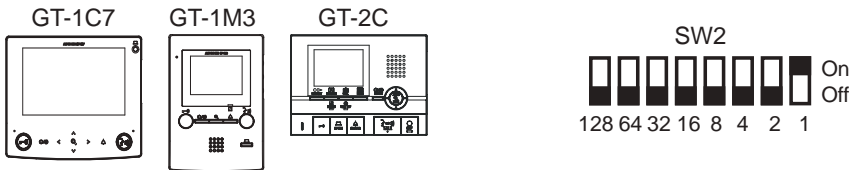

Step 3: Enter Unit Link-ID Setting for each station represented.

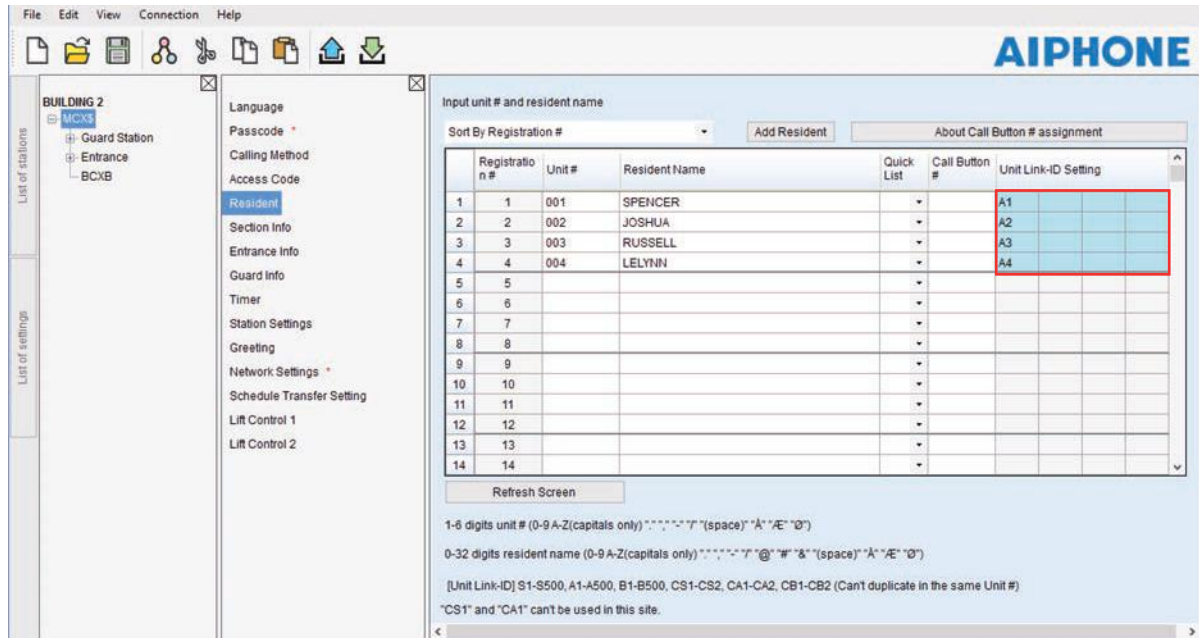

Step 4: Click Save , and then **Yes**.

PROGRAMMING: ENTERING GUARD STATION AND ENTRANCE STATION INFORMATION

Programming Entrance/Guard Information

Step 1: Click the **MCX**, then select **Entrance Info**. Enter 1 for **Section ID**, **Entrance ID (2-16)**, **Entrance #**, and **Entrance Name** (not required).

The GT-MCX uses Entrance ID 1.

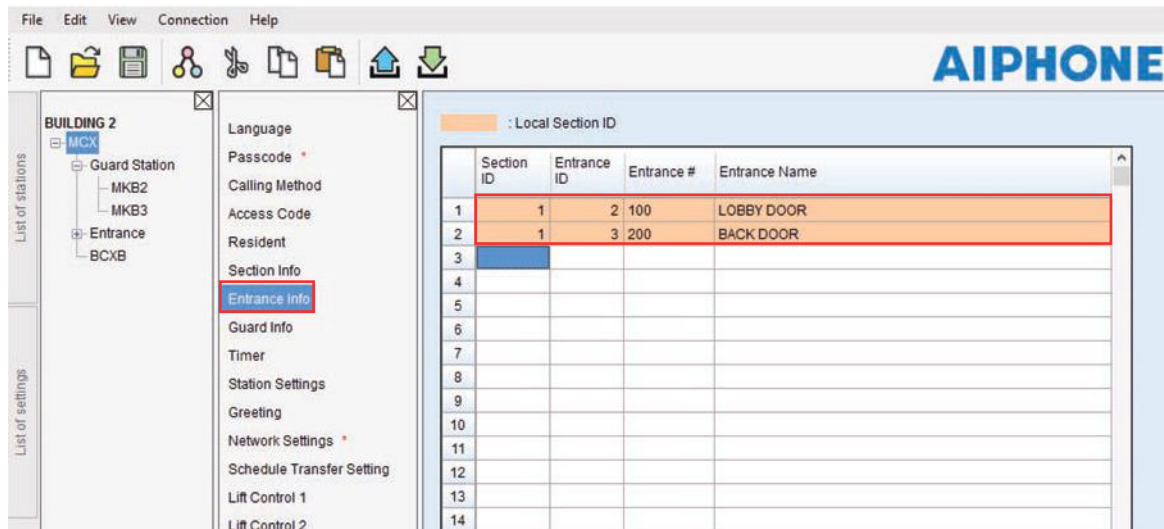

Step 2: Click **Guard Info**. Enter 1 for **Section ID**, **Guard St ID (2-4)**, **Guard #**, and **Guard Name** (not required).

The GT-MCX uses Guard ID 1.

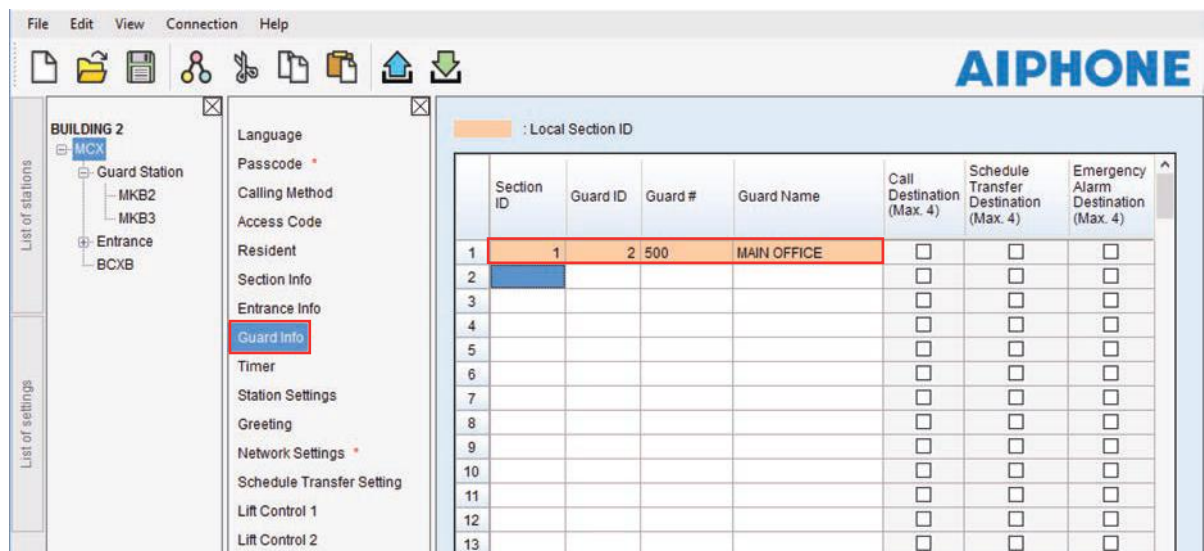

Step 3: Click **Save**, and then **Yes**.

PROGRAMMING: TRANSFER DATA TO OTHER GUARD/ENTRANCE STATIONS

Compare and Merge (copy data to other devices in the system)

Step 1: Click **Compare and Merge Settings**  to copy data to other entry panels and guard stations.

Step 2: In the **Comparison-1** column, select the **MCX** radio button that was programmed. In the **Comparison-2** column, select the desired entrance station/guard station that you want to copy the data to. Click **Compare**.

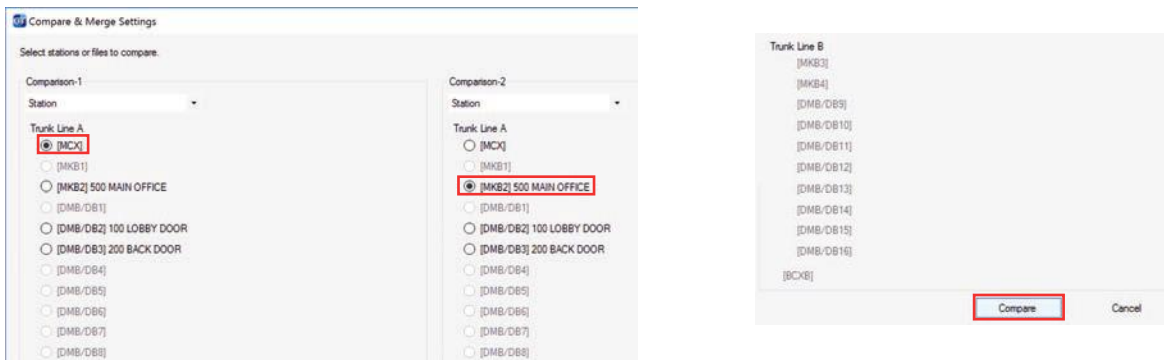

Step 3: Click **Copy All Settings**, then click **Comparison-1 >> Comparison-2** to copy the data to the new station. In the **Do you want to overwrite all of the data?** popup, click **Yes**. Enter the Admin Passcode for the device being copied to. Click OK.

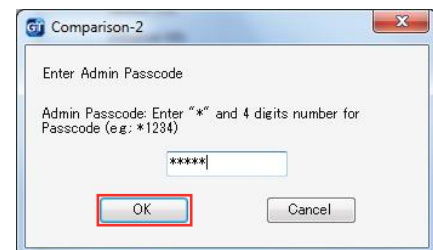
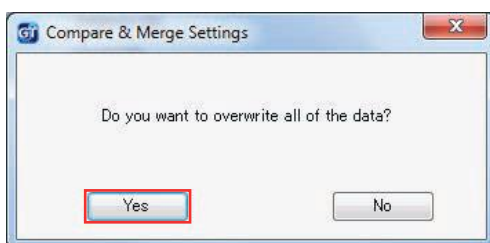
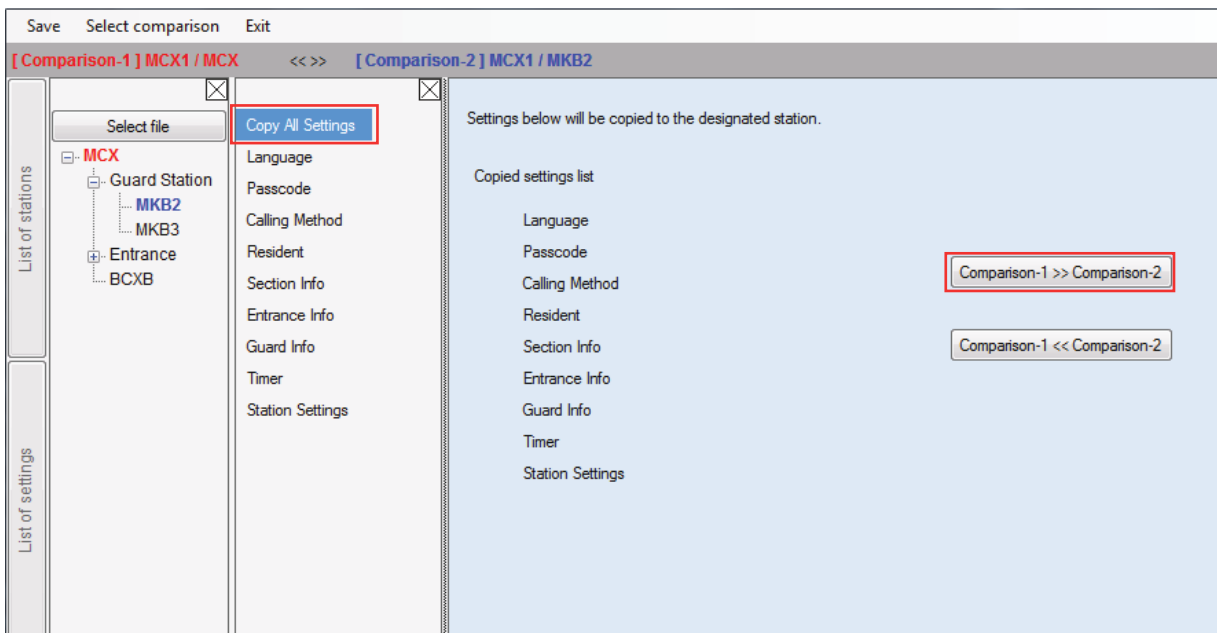

Step 4: Click **Save** , and then **Yes**. Repeat for each station in the system.

PROGRAMMING: UPLOADING TO GT-MCX VIA LAN

Step 1: Click Upload .

Step 2: From the Upload menu, select the **LAN** radio button.



Step 4: Select the desired GT-MCX and verify the correct **IP address**.



Step 5: Select each device that you wish to upload the setting file to. Multiple devices can be selected at the same time. Click **OK**. Click **Yes** in the popup window asking if it's ok to overwrite the selected stations.

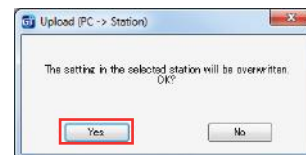
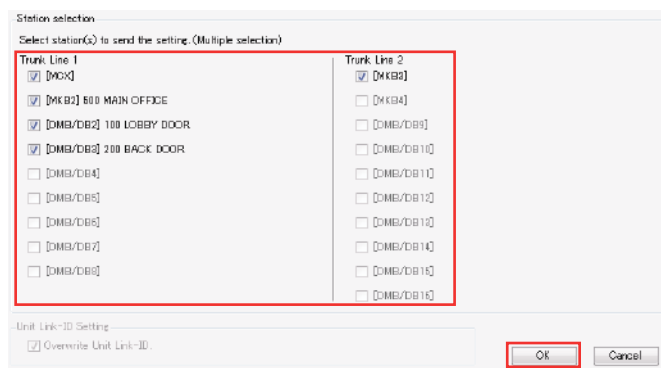

Step 6: Enter the Admin / Manager Passcode and click **OK**. The default Admin Passcode is *1111.

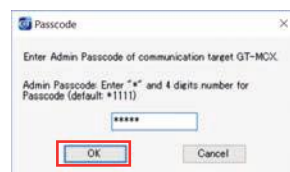

Note:

If the upload to the stations does not work, check the following:

1. Ensure that the entrance station and guard station ID settings are correct. No duplicates on like stations and ID 1 cannot be used.
2. Check that the GT-BC and GT-MCX is connected and powered on.
3. Check that the NIC setting for the GT Support Tool is set correctly. Check this under **Connection > Network Interface Card: NIC**
4. Ensure that you can ping the GT-MCX from your PC.

DIP Switch ID chart:

System without the GT-BCXB-N: Use ID's S1-S48

System with the GT-BCXB-N: Use ID's A1-A250 for stations on sub trunk A of GT-BCXB-N

Use ID's B251-B500 for stations on sub trunk B of GT-BCXB-N

Dip Switch	ID's	Dip Switch	ID's	Dip Switch	ID's	Dip Switch	ID's	Dip Switch	ID's
□□□□□□□□	S1 A1 / B251	□□□□□□□□	S26 A26 / B276	□□□□□□□□	A51 / B301	□□□□□□□□	A76 / B326	□□□□□□□□	A101 / B351
□□□□□□□□	S2 A2 / B252	□□□□□□□□	S27 A27 / B277	□□□□□□□□	A52 / B302	□□□□□□□□	A77 / B327	□□□□□□□□	A102 / B352
□□□□□□□□	S3 A3 / B253	□□□□□□□□	S28 A28 / B278	□□□□□□□□	A53 / B303	□□□□□□□□	A78 / B328	□□□□□□□□	A103 / B353
□□□□□□□□	S4 A4 / B254	□□□□□□□□	S29 A29 / B279	□□□□□□□□	A54 / B304	□□□□□□□□	A79 / B329	□□□□□□□□	A104 / B354
□□□□□□□□	S5 A5 / B255	□□□□□□□□	S30 A30 / B280	□□□□□□□□	A55 / B305	□□□□□□□□	A80 / B330	□□□□□□□□	A105 / B355
□□□□□□□□	S6 A6 / B256	□□□□□□□□	S31 A31 / B281	□□□□□□□□	A56 / B306	□□□□□□□□	A81 / B331	□□□□□□□□	A106 / B356
□□□□□□□□	S7 A7 / B257	□□□□□□□□	S32 A32 / B282	□□□□□□□□	A57 / B307	□□□□□□□□	A82 / B332	□□□□□□□□	A107 / B357
□□□□□□□□	S8 A8 / B258	□□□□□□□□	S33 A33 / B283	□□□□□□□□	A58 / B308	□□□□□□□□	A83 / B333	□□□□□□□□	A108 / B358
□□□□□□□□	S9 A9 / B259	□□□□□□□□	S34 A34 / B284	□□□□□□□□	A59 / B309	□□□□□□□□	A84 / B334	□□□□□□□□	A109 / B359
□□□□□□□□	S10 A10 / B260	□□□□□□□□	S35 A35 / B285	□□□□□□□□	A60 / B310	□□□□□□□□	A85 / B335	□□□□□□□□	A110 / B360
□□□□□□□□	S11 A11 / B261	□□□□□□□□	S36 A36 / B286	□□□□□□□□	A61 / B311	□□□□□□□□	A86 / B336	□□□□□□□□	A111 / B361
□□□□□□□□	S12 A12 / B262	□□□□□□□□	S37 A37 / B287	□□□□□□□□	A62 / B312	□□□□□□□□	A87 / B337	□□□□□□□□	A112 / B362
□□□□□□□□	S13 A13 / B263	□□□□□□□□	S38 A38 / B288	□□□□□□□□	A63 / B313	□□□□□□□□	A88 / B338	□□□□□□□□	A113 / B363
□□□□□□□□	S14 A14 / B264	□□□□□□□□	S39 A39 / B289	□□□□□□□□	A64 / B314	□□□□□□□□	A89 / B339	□□□□□□□□	A114 / B364
□□□□□□□□	S15 A15 / B265	□□□□□□□□	S40 A40 / B290	□□□□□□□□	A65 / B315	□□□□□□□□	A90 / B340	□□□□□□□□	A115 / B365
□□□□□□□□	S16 A16 / B266	□□□□□□□□	S41 A41 / B291	□□□□□□□□	A66 / B316	□□□□□□□□	A91 / B341	□□□□□□□□	A116 / B366
□□□□□□□□	S17 A17 / B267	□□□□□□□□	S42 A42 / B292	□□□□□□□□	A67 / B317	□□□□□□□□	A92 / B342	□□□□□□□□	A117 / B367
□□□□□□□□	S18 A18 / B268	□□□□□□□□	S43 A43 / B293	□□□□□□□□	A68 / B318	□□□□□□□□	A93 / B343	□□□□□□□□	A118 / B368
□□□□□□□□	S19 A19 / B269	□□□□□□□□	S44 A44 / B294	□□□□□□□□	A69 / B319	□□□□□□□□	A94 / B344	□□□□□□□□	A119 / B369
□□□□□□□□	S20 A20 / B270	□□□□□□□□	S45 A45 / B295	□□□□□□□□	A70 / B320	□□□□□□□□	A95 / B345	□□□□□□□□	A120 / B370
□□□□□□□□	S21 A21 / B271	□□□□□□□□	S46 A46 / B296	□□□□□□□□	A71 / B321	□□□□□□□□	A96 / B346	□□□□□□□□	A121 / B371
□□□□□□□□	S22 A22 / B272	□□□□□□□□	S47 A47 / B297	□□□□□□□□	A72 / B322	□□□□□□□□	A97 / B347	□□□□□□□□	A122 / B372
□□□□□□□□	S23 A23 / B273	□□□□□□□□	S48 A48 / B298	□□□□□□□□	A73 / B323	□□□□□□□□	A98 / B348	□□□□□□□□	A123 / B373
□□□□□□□□	S24 A24 / B274	□□□□□□□□	A49 / B299	□□□□□□□□	A74 / B324	□□□□□□□□	A99 / B349	□□□□□□□□	A124 / B374
□□□□□□□□	S25 A25 / B275	□□□□□□□□	A50 / B300	□□□□□□□□	A75 / B325	□□□□□□□□	A100 / B350	□□□□□□□□	A125 / B375

DIP Switch ID chart (cont):

System with the GT-BCXB-N: Use ID's A1-A250 for stations on sub trunk A of GT-BCXB-N
 Use ID's B251-B500 for stations on sub trunk B of GT-BCXB-N

Dip Switch	ID's	Dip Switch	ID's	Dip Switch	ID's	Dip Switch	ID's	Dip Switch	ID's
☐☐☐☐☐☐☐☐	A126 / B376	☐☐☐☐☐☐☐☐	A151 / B401	☐☐☐☐☐☐☐☐	A176 / B426	☐☐☐☐☐☐☐☐	A201 / B451	☐☐☐☐☐☐☐☐	A226 / B476
☐☐☐☐☐☐☐☐	A127 / B377	☐☐☐☐☐☐☐☐	A152 / B402	☐☐☐☐☐☐☐☐	A177 / B427	☐☐☐☐☐☐☐☐	A202 / B452	☐☐☐☐☐☐☐☐	A227 / B477
☐☐☐☐☐☐☐☐	A128 / B378	☐☐☐☐☐☐☐☐	A153 / B403	☐☐☐☐☐☐☐☐	A178 / B428	☐☐☐☐☐☐☐☐	A203 / B453	☐☐☐☐☐☐☐☐	A228 / B478
☐☐☐☐☐☐☐☐	A129 / B379	☐☐☐☐☐☐☐☐	A154 / B404	☐☐☐☐☐☐☐☐	A179 / B429	☐☐☐☐☐☐☐☐	A204 / B454	☐☐☐☐☐☐☐☐	A229 / B479
☐☐☐☐☐☐☐☐	A130 / B380	☐☐☐☐☐☐☐☐	A155 / B405	☐☐☐☐☐☐☐☐	A180 / B430	☐☐☐☐☐☐☐☐	A205 / B455	☐☐☐☐☐☐☐☐	A230 / B480
☐☐☐☐☐☐☐☐	A131 / B381	☐☐☐☐☐☐☐☐	A156 / B406	☐☐☐☐☐☐☐☐	A181 / B431	☐☐☐☐☐☐☐☐	A206 / B456	☐☐☐☐☐☐☐☐	A231 / B481
☐☐☐☐☐☐☐☐	A132 / B382	☐☐☐☐☐☐☐☐	A157 / B407	☐☐☐☐☐☐☐☐	A182 / B432	☐☐☐☐☐☐☐☐	A207 / B457	☐☐☐☐☐☐☐☐	A232 / B482
☐☐☐☐☐☐☐☐	A133 / B383	☐☐☐☐☐☐☐☐	A158 / B408	☐☐☐☐☐☐☐☐	A183 / B433	☐☐☐☐☐☐☐☐	A208 / B458	☐☐☐☐☐☐☐☐	A233 / B483
☐☐☐☐☐☐☐☐	A134 / B384	☐☐☐☐☐☐☐☐	A159 / B409	☐☐☐☐☐☐☐☐	A184 / B434	☐☐☐☐☐☐☐☐	A209 / B459	☐☐☐☐☐☐☐☐	A234 / B484
☐☐☐☐☐☐☐☐	A135 / B385	☐☐☐☐☐☐☐☐	A160 / B410	☐☐☐☐☐☐☐☐	A185 / B435	☐☐☐☐☐☐☐☐	A210 / B460	☐☐☐☐☐☐☐☐	A235 / B485
☐☐☐☐☐☐☐☐	A136 / B386	☐☐☐☐☐☐☐☐	A161 / B411	☐☐☐☐☐☐☐☐	A186 / B436	☐☐☐☐☐☐☐☐	A211 / B461	☐☐☐☐☐☐☐☐	A236 / B486
☐☐☐☐☐☐☐☐	A137 / B387	☐☐☐☐☐☐☐☐	A162 / B412	☐☐☐☐☐☐☐☐	A187 / B437	☐☐☐☐☐☐☐☐	A212 / B462	☐☐☐☐☐☐☐☐	A237 / B487
☐☐☐☐☐☐☐☐	A138 / B388	☐☐☐☐☐☐☐☐	A163 / B413	☐☐☐☐☐☐☐☐	A188 / B438	☐☐☐☐☐☐☐☐	A213 / B463	☐☐☐☐☐☐☐☐	A238 / B488
☐☐☐☐☐☐☐☐	A139 / B389	☐☐☐☐☐☐☐☐	A164 / B414	☐☐☐☐☐☐☐☐	A189 / B439	☐☐☐☐☐☐☐☐	A214 / B464	☐☐☐☐☐☐☐☐	A239 / B489
☐☐☐☐☐☐☐☐	A140 / B390	☐☐☐☐☐☐☐☐	A165 / B415	☐☐☐☐☐☐☐☐	A190 / B440	☐☐☐☐☐☐☐☐	A215 / B465	☐☐☐☐☐☐☐☐	A240 / B490
☐☐☐☐☐☐☐☐	A141 / B391	☐☐☐☐☐☐☐☐	A166 / B416	☐☐☐☐☐☐☐☐	A191 / B441	☐☐☐☐☐☐☐☐	A216 / B466	☐☐☐☐☐☐☐☐	A241 / B491
☐☐☐☐☐☐☐☐	A142 / B392	☐☐☐☐☐☐☐☐	A167 / B417	☐☐☐☐☐☐☐☐	A192 / B442	☐☐☐☐☐☐☐☐	A217 / B467	☐☐☐☐☐☐☐☐	A242 / B492
☐☐☐☐☐☐☐☐	A143 / B393	☐☐☐☐☐☐☐☐	A168 / B418	☐☐☐☐☐☐☐☐	A193 / B443	☐☐☐☐☐☐☐☐	A218 / B468	☐☐☐☐☐☐☐☐	A243 / B493
☐☐☐☐☐☐☐☐	A144 / B394	☐☐☐☐☐☐☐☐	A169 / B419	☐☐☐☐☐☐☐☐	A194 / B444	☐☐☐☐☐☐☐☐	A219 / B469	☐☐☐☐☐☐☐☐	A244 / B494
☐☐☐☐☐☐☐☐	A145 / B395	☐☐☐☐☐☐☐☐	A170 / B420	☐☐☐☐☐☐☐☐	A195 / B445	☐☐☐☐☐☐☐☐	A220 / B470	☐☐☐☐☐☐☐☐	A245 / B495
☐☐☐☐☐☐☐☐	A146 / B396	☐☐☐☐☐☐☐☐	A171 / B421	☐☐☐☐☐☐☐☐	A196 / B446	☐☐☐☐☐☐☐☐	A221 / B471	☐☐☐☐☐☐☐☐	A246 / B496
☐☐☐☐☐☐☐☐	A147 / B397	☐☐☐☐☐☐☐☐	A172 / B422	☐☐☐☐☐☐☐☐	A197 / B447	☐☐☐☐☐☐☐☐	A222 / B472	☐☐☐☐☐☐☐☐	A247 / B497
☐☐☐☐☐☐☐☐	A148 / B398	☐☐☐☐☐☐☐☐	A173 / B423	☐☐☐☐☐☐☐☐	A198 / B448	☐☐☐☐☐☐☐☐	A223 / B473	☐☐☐☐☐☐☐☐	A248 / B498
☐☐☐☐☐☐☐☐	A149 / B399	☐☐☐☐☐☐☐☐	A174 / B424	☐☐☐☐☐☐☐☐	A199 / B449	☐☐☐☐☐☐☐☐	A224 / B474	☐☐☐☐☐☐☐☐	A249 / B499
☐☐☐☐☐☐☐☐	A150 / B400	☐☐☐☐☐☐☐☐	A175 / B425	☐☐☐☐☐☐☐☐	A200 / B450	☐☐☐☐☐☐☐☐	A225 / B475	☐☐☐☐☐☐☐☐	A250 / B500