

AIPHONE

GT SYSTEM

Standard & Expanded System

SETTING MANUAL

Thank you for selecting Aiphone for your communication needs. Please read this manual carefully before installation, and keep this in a safe place for future reference.

Please note that images and illustrations depicted in this manual may differ from the actual product.

Table of Contents

READ THIS BEFORE SETTING UP THE SYSTEM

1	Notes about using this manual.....	3
2	Outline of link setting.....	4
3	DIP switch settings (confirm in advance).....	7
3-1	Entrance station, guard station, expanded bus control unit.....	7
3-2	Residential/tenant station.....	10

SYSTEM SETUP USING GT SETUP TOOL

4	Outline of settings.....	11
5	Initial setup.....	12
5-1	Installing the GT Setup Tool.....	12
5-2	Creating a new site.....	13
5-3	Changing the setting contents for an existing site ...	14
6	System settings.....	15
6-1	Registering resident information.....	15
6-2	Guard and entrance station settings.....	16
7	Functions in the menu bar.....	19
7-1	Function list.....	19
7-2	Changing site configuration.....	20
7-3	Comparing and merging setting contents between stations or files.....	21
7-4	Uploading setting data configured by the GT Setup Tool to an entrance station, guard station or expanded bus control unit.....	23
7-5	Downloading setting data configured on an entrance station, guard station or expanded bus control unit to the GT Setup Tool.....	24

SYSTEM SETUP USING ENTRANCE/GUARD STATION

8	Setting up a link among stations.....	25
8-1	Setting up a link using a modular type entrance station (GT-DB(-V, -VN)/GT-NSB/GT-SW).....	25
8-2	Setting up a link using an all-in-one type entrance station (GT-DMB-N/GT-DMB-LVN).....	28
8-3	Setting up a link using a guard station (GT-MKB-N).....	31
9	Station settings.....	35
9-1	Setting item list.....	35
9-2	Basic setting operation.....	38
	Using a modular type entrance station (name scrolling module (GT-NSB)/10 key module (GT-10K)).....	38
	Using an all-in-one type entrance station (GT-DMB-N/GT-DMB-LVN).....	39
	Using a guard station (GT-MKB-N).....	40
9-3	Setting item description.....	42
	SELECT LANGUAGE.....	42
	CHANGE PASSCODE.....	42
	PROGRAMMING.....	42
	SYSTEM SETTINGS.....	42
	STATION SETTINGS.....	43
	OTHER SETTINGS.....	47

SETTINGS ON RESIDENTIAL/TENANT STATION

10	Changing settings on GT-2C-L/GT-2C only.....	48
10-1	How to use the MENU.....	48
10-2	Guard station settings.....	48
10-3	Emergency input settings.....	49
10-4	External input setting.....	49
10-5	Doctor call setting.....	51
10-6	Press-to-talk setting.....	51
10-7	Call ID display setting.....	51
10-8	Initializing.....	52

Notices

- We will under no condition be liable for any damages or losses resulting from this product's contents or specifications.
- This manual was created by Aiphone Co., Ltd., all rights reserved. Copying a part of or this entire manual without prior permission from Aiphone Co., Ltd. is strictly prohibited.
- This manual may be revised or changed without prior notice.
- Product specifications may be changed for the sake of improvement without prior notice.



READ THIS BEFORE SETTING UP THE SYSTEM



1 Notes about using this manual

This manual describes how to configure the settings for the **Standard & Expanded System**. For the **Multi Building System**, also read the **GT SYSTEM SETTING MANUAL/Multi Building System**.

The GT system allows the following tools and stations to be used for configuring settings. However, all settings may not be configurable depending on the tool or stations used.

This manual uses icons for symbolizing the tools and stations used for each setting item.

Icon	Tool
	GT Setup Tool for Windows (*1)
	GT Setup Tool for Android (*2)

Icon	Station
	Modular type entrance station
	All-in-one type entrance station (GT-DMB-N(-LVN))
	Guard station (GT-MKB-N)

(*1): Described as "GT Setup Tool" in this manual.

(*2): This manual does not cover how to use the GT Setup Tool for Android. Refer to the **GT SYSTEM SETTING MANUAL/GT Setup Tool for Android** for details.

Microsoft and Windows are either registered trademarks or trademarks of Microsoft Corporation in the United States and/or other countries.

Android is a trademark of Google Inc. in the United States and/or other countries.

Adobe, the Adobe logo, Acrobat, and Reader are either registered trademarks or trademarks of Adobe Systems Incorporated in the United States and/or other countries.

VIGIK is either a registered trademark or trademark of La POSTE in France.

HEXACT® is either a registered trademark or trademark of Cogelec in France.

2 Outline of link setting

When the installation of the GT system has finished, configure the link settings among all the stations in the system before using the system by following the steps on the next page. The GT system enables calling and communication among the linked stations only. The settings can be configured by using the GT Setup Tool for Windows, an entrance station, a guard station, or the GT Setup Tool for Android. The setting method differs depending on the tool or device used. Select the method suitable for the environment or setup plan of your system by referring to the **link setting methods** on the next page.

NOTE:

Configure the settings correctly. If the settings have not been configured correctly, the system will not function as you planned.

Term definition

(*1): UNIT Link-ID

All video residential/tenant stations can have "UNIT Link-ID" set by the DIP switches on SW2.

There are 2 methods for setting the UNIT Link-IDs.

Automatic setting	Set the DIP switches to "0000 0000". The UNIT Link-ID is set automatically.
Manual setting	Set the UNIT Link-IDs by using the DIP switches. Decide the UNIT Link-IDs in advance, and coordinate the DIP switch settings on SW2 with the system installer.

NOTES:

- GT-1D and GT-1A do not have DIP Switches for UNIT Link-ID. They must be set using the "Handshake method".
- The "Automatic setting" and "Manual setting" methods cannot be mixed in the same site.

(*2): Link setting method

There are two methods for link setting.

Handshake method	The entrance/guard stations must be put into programming mode and communication must be established with each residential/tenant station. Either "Automatic setting" or "Manual setting" is available.
Using the Setup Tool	Every residential/tenant station must be set with a unique UNIT Link-ID. Link setting is configured by using the GT Setup Tool. Only the "Manual setting" is available for setting the UNIT Link-IDs. The DIP switches on SW2 must be set in advance.

NOTE:

In case of using "Manual setting" with the "Handshake method"
If there is a mixture of video and audio residential/tenant stations in the same site, the UNIT Link-IDs for video stations must be set first to avoid ID duplication.

■ Link setting methods

First select the setting method **A** to **D** below according to the environment or setup plan, etc. of your system. The methods are divided in two groups depending on whether to use the GT Setup Tool or not.

NOTE:

First confirm how are the UNIT Link-IDs set by checking the DIP switch settings on SW2.

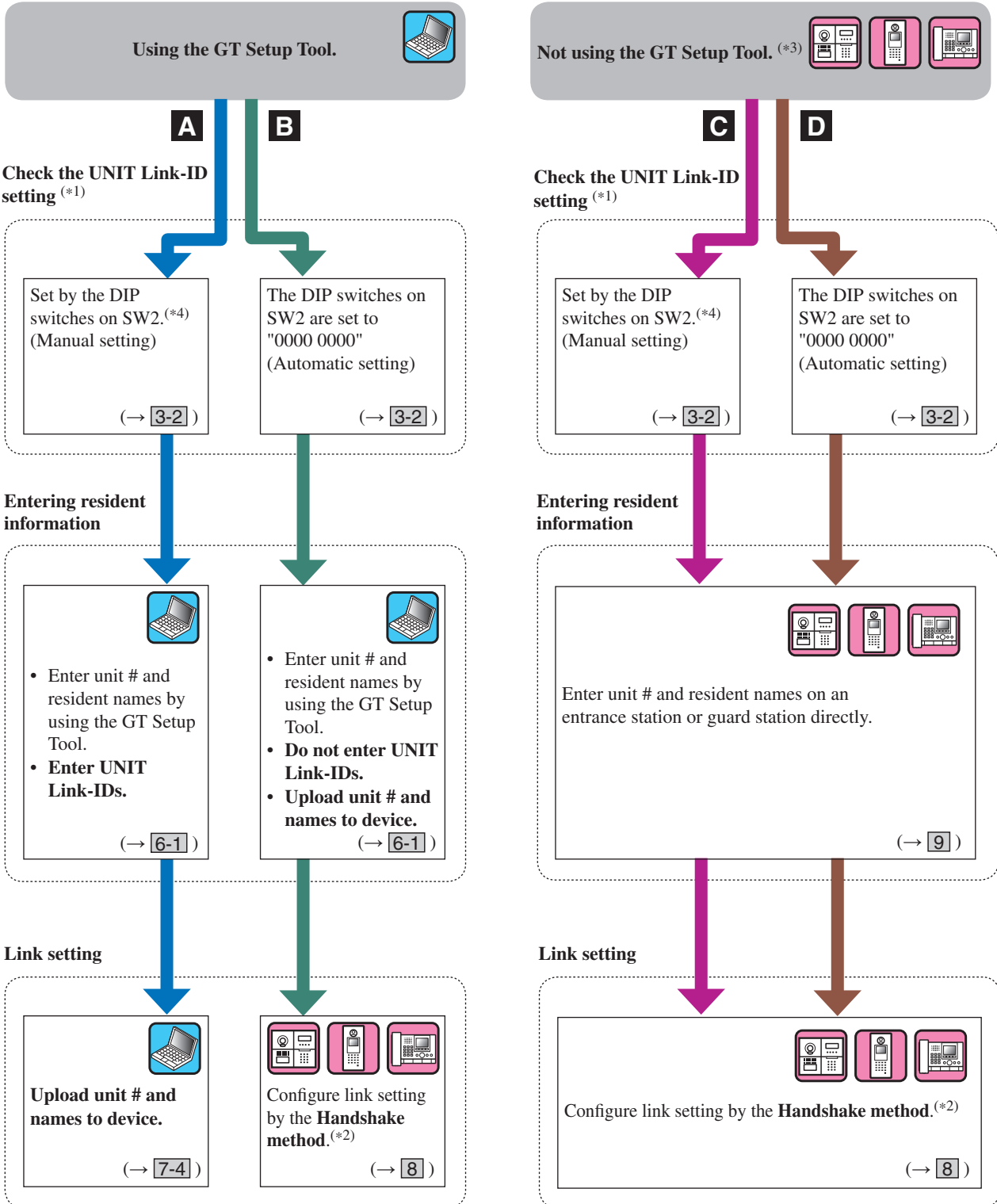

(*3): NFC card can be registered/deleted on a station without the GT Setup Tool.

(*4): The residential/tenant station models that allow setting the UNIT Link-IDs with the DIP switches on SW2 are GT-2C(-L), GT-1C7(-L) and GT-1M3(-L) only.

READ THIS BEFORE SETTING UP THE SYSTEM

Features of each setting method

A: Use the GT Setup Tool only for entering information and link setting **Recommended**

All settings can be configured on a PC. This method is ideal when programming a large system.
The UNIT Link-ID setting must be completed by using the DIP switches on SW2 in advance.

B: Using the GT Setup Tool only for entering information / Handshake method for link setting (Automatic ID setting)

There is no need of setting the DIP switches, and resident information can be set all at once by using the GT Setup Tool.
When replacing a residential/tenant station due to malfunction, the link must be reset. (During reset, calling and communication are disabled to the residential/tenant station.)

C: Direct input for entering information / Handshake method for link setting (Manual ID setting)

This is suitable for a small system because the settings can be configured in a short time.
The UNIT Link-ID setting must be completed by using the DIP switches on SW2 in advance.

D: Direct input for entering information / Handshake method for link setting (Automatic ID setting)

This is suitable for a small system because the settings can be configured in a short time.

3 DIP switch settings (confirm in advance)

Verify that the DIP switches on each device are set correctly prior to using the GT Setup Tool to configure settings.

NOTE:

When any DIP switch setting has been performed, cycle power before performing other settings. Otherwise, the settings may not be changed.

3-1 Entrance station, guard station, expanded bus control unit

Entrance station (modular type)

Audio module (GT-DB, GT-DB-V, GT-DB-VN)

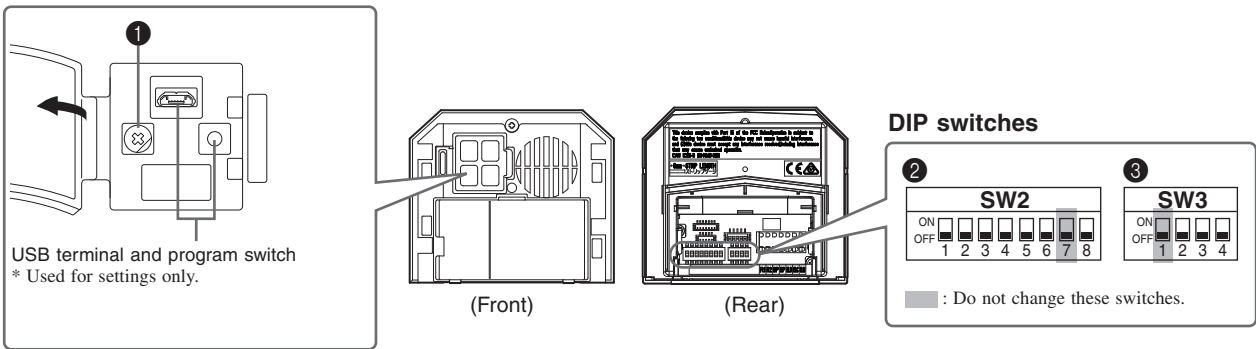

1 VR1 dial (inside the cover)

Function	Default
Sets the door release duration time. Setting range: M (Momentary)/0.5-20 seconds	M (Momentary)

2 SW2

No.	Function	Default
1	Sets this entrance station as used for either a multi building system or single building system. ON: Multi building system OFF: Single building system	OFF
2 to 4	Sets the ID of this entrance station. * (9) - (16): GT-BCXB-N Common trunk line 2 ID number Positions of switch 2 to 4	2: OFF 3: OFF 4: OFF (ID 1)
5	Sets the ability of this entrance station to be monitored by the guard station or residential/tenant station. ON: Allowed OFF: Not allowed	OFF

No.	Function	Default
6	* This setting is needed only in France. Set the transmission method for VIGIK. ON: HEXACT® version OFF: AIPHONE version	OFF
8	Resets the Admin Passcode and Manager Passcode when this unit is initialized by setting this switch to ON for 2 seconds. * After reset, be sure to set this switch to OFF.	OFF

3 SW3

No.	Function	Default
2 to 4	Sets the language for audio guidance by the combination of the switch 2 to 4 settings. (No guidance) English Positions of switch 2 to 4 French German Spanish Dutch Norwegian (Tone) 	2: OFF 3: OFF 4: OFF (No guidance)



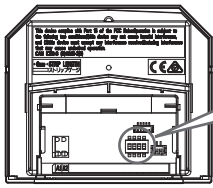

Camera module (GT-VB)

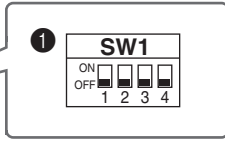

DIP switches



1 SW1

No.	Function	Default
1	Sets the night illumination. ON: Always off OFF: Turns on/off automatically	OFF
2	Sets whether a surveillance camera or light is attached. ON: Surveillance camera OFF: Light control	OFF
3 to 4	Sets the display mode at the beginning of a call. <div style="display: flex; justify-content: space-around;"> <div style="text-align: center;"> <p>Zoom</p>  </div> <div style="text-align: center;"> <p>Wide</p>  </div> </div> <p>Positions of switch 3 and 4</p> <p>Zoom (3 seconds) → Wide</p>  <p>Wide (3 seconds) → Zoom</p> 	3: OFF 4: OFF (Zoom)

Entrance station (all-in-one type)

GT-DMB-LVN, GT-DMB-N

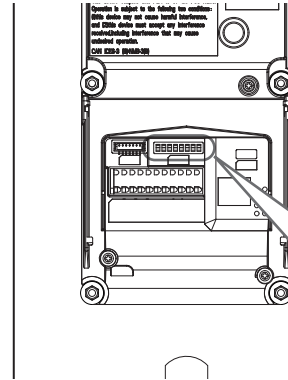



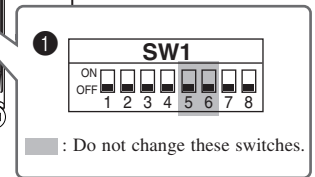







DIP switches



■ : Do not change these switches.

1 SW1

No.	Function	Default
1	Sets this entrance station as used for either a multi building system or single building system. ON: Multi building system OFF: Single building system	OFF
2 to 4	Sets the ID of this entrance station. * (9) - (16): GT-BCXB-N Common trunk line 2 ID number <div style="display: flex; flex-direction: column; align-items: center;"> <div style="display: flex; justify-content: space-around; width: 100%;"> <div style="text-align: center;"> <p>1</p>  <p>(9)</p> </div> <div style="text-align: center;"> <p>2</p>  <p>(10)</p> </div> <div style="text-align: center;"> <p>3</p>  <p>(11)</p> </div> </div> <p>Positions of switch 2 to 4</p> <div style="display: flex; justify-content: space-around; width: 100%;"> <div style="text-align: center;"> <p>4</p>  <p>(12)</p> </div> <div style="text-align: center;"> <p>5</p>  <p>(13)</p> </div> </div> <div style="display: flex; justify-content: space-around; width: 100%; margin-top: 10px;"> <div style="text-align: center;"> <p>6</p>  <p>(14)</p> </div> <div style="text-align: center;"> <p>7</p>  <p>(15)</p> </div> <div style="text-align: center;"> <p>8</p>  <p>(16)</p> </div> </div> </div>	2: OFF 3: OFF 4: OFF (ID 1)
7	Sets the event that triggers the LCD. Sensor detection Operation of this unit  	OFF (Sensor detection)
8	Resets the Admin Passcode and Manager Passcode when this unit is initialized by setting this switch to ON for 2 seconds. * After reset, be sure to set this switch to OFF.	OFF

READ THIS BEFORE SETTING UP THE SYSTEM

Guard station

GT-MKB-N

DIP switches

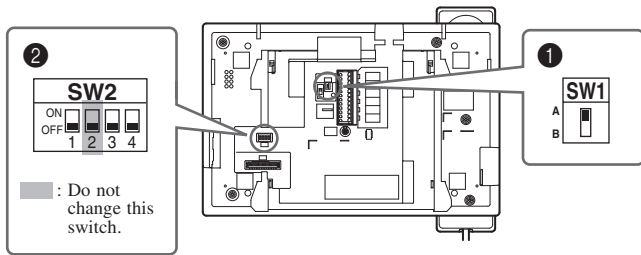

1 SW1

Function	Default
For terminating a guard station, set SW1 to "A". When not terminating, set to "B".	A

2 SW2

No.	Function	Default
1	Sets this unit as used for either a multi building system or single building system. ON: Multi building system OFF: Single building system	OFF
3	Sets the ID of this unit. * (3), (4): GT-BCXB-N Common trunk line 2 ON: ID 2 (4) OFF: ID 1 (3)	OFF (ID 1)
4	Resets the Admin Passcode and Manager Passcode when this unit is initialized by setting this switch to ON for 2 seconds. * After reset, be sure to set this switch to OFF.	OFF

Expanded bus control unit

GT-BCXB-N

Power switch

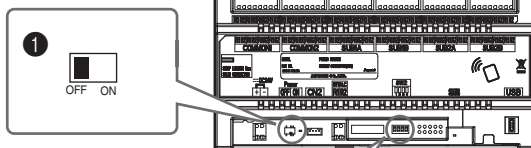

DIP switches

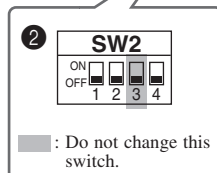

1 Power switch

Set the switch to ON when using this unit.

2 SW2

No.	Function	Default
1	Sets this unit as used for either a multi building system or single building system. ON: Multi building system OFF: Single building system	OFF
2	Sets this unit as to be used for either a tenant section or main section. ON: Main section OFF: Tenant section	OFF
4	Resets the Admin Passcode and Manager Passcode when this unit is initialized by setting this switch to ON for 2 seconds. * After reset, be sure to set this switch to OFF.	OFF

3-2 Residential/tenant station

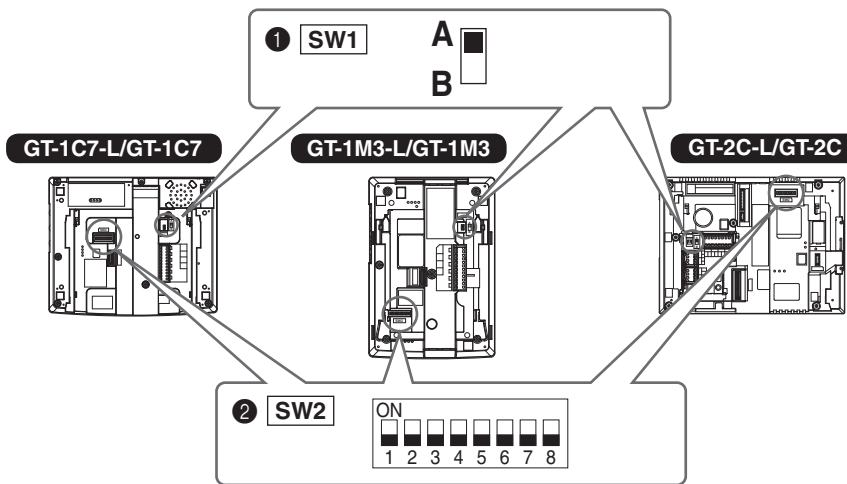

1 SW1

Function	Default
To terminate a residential/tenant station, leave SW1 set to "A". Otherwise, set to "B". * Refer to the GT SYSTEM INSTALLATION MANUAL/ Standard & Expanded System 4 "WIRING" for details about the SW1 settings.	A

2 SW2

Residential/tenant stations must be linked to entrance/guard stations for enabling calling and communication. All video residential/tenant stations can have "UNIT Link-ID" set by using SW2.

Function	Default
The DIP switches of SW2 must be used when setting UNIT Link-IDs by using the "Manual Setting" method. If using the "Automatic Setting" method, do not change the default setting "0000 0000".	1: OFF 2: OFF 3: OFF 4: OFF 5: OFF 6: OFF 7: OFF 8: OFF (0000 0000)
<ul style="list-style-type: none"> Automatic setting: Set the DIP switches to "0000 0000". The UNIT Link-ID is set automatically. * For GT-1D and GT-1A, UNIT Link-ID is always set using the "Handshake method". Manual setting: Set the UNIT Link-ID by using the DIP switches. Decide the UNIT Link-IDs in advance, and coordinate with the system installer for SW2 DIP switch settings. 	
NOTE: If there is mixture of video and audio residential/tenant stations in the site, only Automatic setting should be used.	

How to set "UNIT Link-ID"

There are two methods for link setting.

By Handshake method	The entrance/guard stations must be put into programming mode and communication must be established one-by-one with each resident station. Either "Automatic setting" or "Manual setting" is available.
By GT Setup Tool	Every residential/tenant station must be set with a unique residence UNIT Link-ID, as shown below. Link establishment is performed with the GT setup tool. Only the "Manual setting" for UNIT Link-IDs is available. The DIP switches on SW2 must be set in advance.

Manual setting

1 Change the decimal notation ID to binary to set the residence ID.

- 1 indicates (ON) and 0 indicates (OFF).
- For binary notation, refer to the DIP switch & ID list for residential/tenant stations^(*) in the setup tool and perform settings as shown below.

Decimal notation	Binary notation	DIP switches
1	0000 0001	<input type="checkbox"/> <input type="checkbox"/> <input type="checkbox"/> <input type="checkbox"/> <input type="checkbox"/> <input type="checkbox"/> <input type="checkbox"/> <input type="checkbox"/>
2	0000 0010	<input type="checkbox"/> <input type="checkbox"/> <input type="checkbox"/> <input type="checkbox"/> <input type="checkbox"/> <input type="checkbox"/> <input type="checkbox"/> <input type="checkbox"/>
3	0000 0011	<input type="checkbox"/> <input type="checkbox"/> <input type="checkbox"/> <input type="checkbox"/> <input type="checkbox"/> <input type="checkbox"/> <input type="checkbox"/> <input type="checkbox"/>
4	0000 0100	<input type="checkbox"/> <input type="checkbox"/> <input type="checkbox"/> <input type="checkbox"/> <input type="checkbox"/> <input type="checkbox"/> <input type="checkbox"/> <input type="checkbox"/>
⋮	⋮	⋮
48	0011 0000	<input type="checkbox"/> <input type="checkbox"/> <input type="checkbox"/> <input type="checkbox"/> <input type="checkbox"/> <input type="checkbox"/> <input type="checkbox"/> <input type="checkbox"/>
⋮	⋮	⋮
250	1111 1010	<input type="checkbox"/> <input type="checkbox"/> <input type="checkbox"/> <input type="checkbox"/> <input type="checkbox"/> <input type="checkbox"/> <input type="checkbox"/> <input type="checkbox"/>

2 Create a correlation table with the setup tool between the ID set for residences/tenants and the residential/tenant station names and upload this to the entrance station or guard station.

- * Saving programmed data and resident information data to your PC is recommended.

(*1): The DIP switch & ID list for residential/tenant stations is available from the Aiphone website.

SYSTEM SETUP USING GT SETUP TOOL

4 Outline of settings



When the installation of the GT system has finished, configure the settings for the whole system before using it by following the steps below. All settings can be completed by using the GT Setup Tool for Windows. You can also configure the settings on an entrance station and guard station. Moreover, the GT Setup Tool for Android is available to configure the settings for stations with NFC.

Step 1

Initial setup

1. Install the GT Setup Tool for Windows (→ [5-1](#)) (or install the GT Setup Tool for Android).
2. Set the level of access authorization for the settings (Admin). (→ [5-2](#))
3. Create a new site. (→ [5-2](#))
 - Setting the site configuration.
 - Set the number of guard stations and entrance stations according to the site configuration.



Step 2

Link setting

Follow the procedure of "Link setting methods".
(→ [6-1](#), [8](#))



Step 3

Configure the settings for each station.

(→ [6-2](#), [9](#))



5 Initial setup



5-1 Installing the GT Setup Tool

Step 1

■ System requirements for PC

Your PC must meet the following minimum system requirements to use the GT Setup Tool.

OS	Windows 7 (Service Pack 1) Windows 8.1 Windows 10
Processor	1 GHz
System memory (RAM)	2 GB RAM
Hard disk	Total 100 MB (*1)
Run-time	Microsoft® .NET Framework 4.5 (*2)
Display	1024 (W) x 768 (H), 16-bit
USB port	Type-A

(*1): If the software is to be installed onto a drive other than C: drive, both the C: drive and the installation drive each require 50 MB or more of storage space.

(*2): If the specified Run-time is not installed on the PC, it will be installed automatically when installing the GT Setup Tool.

NOTES:

- The application may not run, or may not operate correctly (such as freezes occurring) on a PC with specifications below the necessary requirements.
- We recommend using a PC that exceeds the basic system requirements.

■ Installing the GT Setup Tool

* You may need to log on to your PC as the Administrator to install the GT Setup Tool.

1 Download the "Aiphone GT Setup Tool for Windows" installer on your PC from "www.aiphone.net".

2 Double-click the "Aiphone GT Setup Tool for Windows" installer, then follow the on-screen instructions.

* When a dialog box is displayed asking to install the following drivers, click **[OK]**.

- Aiphone GT Setup Tool for Windows USB driver
- Aiphone GT Setup Tool for Windows USB to UART Bridge Driver

5-2 Creating a new site

Step 1

1 Double-click the "Aiphone GT Setup Tool for Windows" icon on the desktop, or run "gt_settingtool.exe".

The "Select an operation" dialog box opens.

2 Select "Create new site" when configuring a new system, then click **OK**.

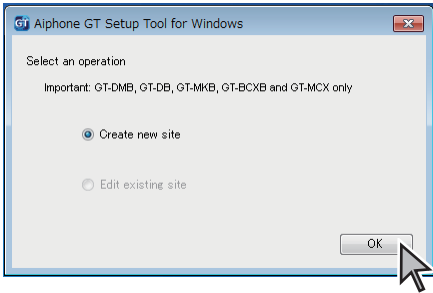

The "Create new site: Site configuration" window opens.

* When changing the setting contents for an existing site (→ 5-3)

3 Set the following items, then click **Next**.

Item	Choices	Note
Setting authorization	Admin/Manager	Admin: Full access to all settings. Manager: Partial access to settings.
Site configuration	Single building system/ Multi building system	Select "Single building system" (*1)

(*1): This manual does not cover a multi building system. For a multi building system, refer to **GT SYSTEM SETTING MANUAL/Multi building system**.

* All items can be set when accessed with the **Admin** authorization. The items in cannot be set with the **Manager** authorization. (→ 6-2)

4 Set the following items, then click **OK**.

Item	Description
Site name	Enter a new site name.
Section Control Unit (GT-MCX)	Select the number of GT-MCX, "0" or "1". Refer to GT SYSTEM SETTING MANUAL/Multi Building System for GT-MCX setting.
Expanded Bus Control Unit (GT-BCXB)	When using GT-BCXB-N, select "1".
Number of Guards	Select the number of guard stations used in the site.
Number of Entrances	Select the number of entrance stations used in the site.

The setting screen for the site opens.

Setting screen for the selected site

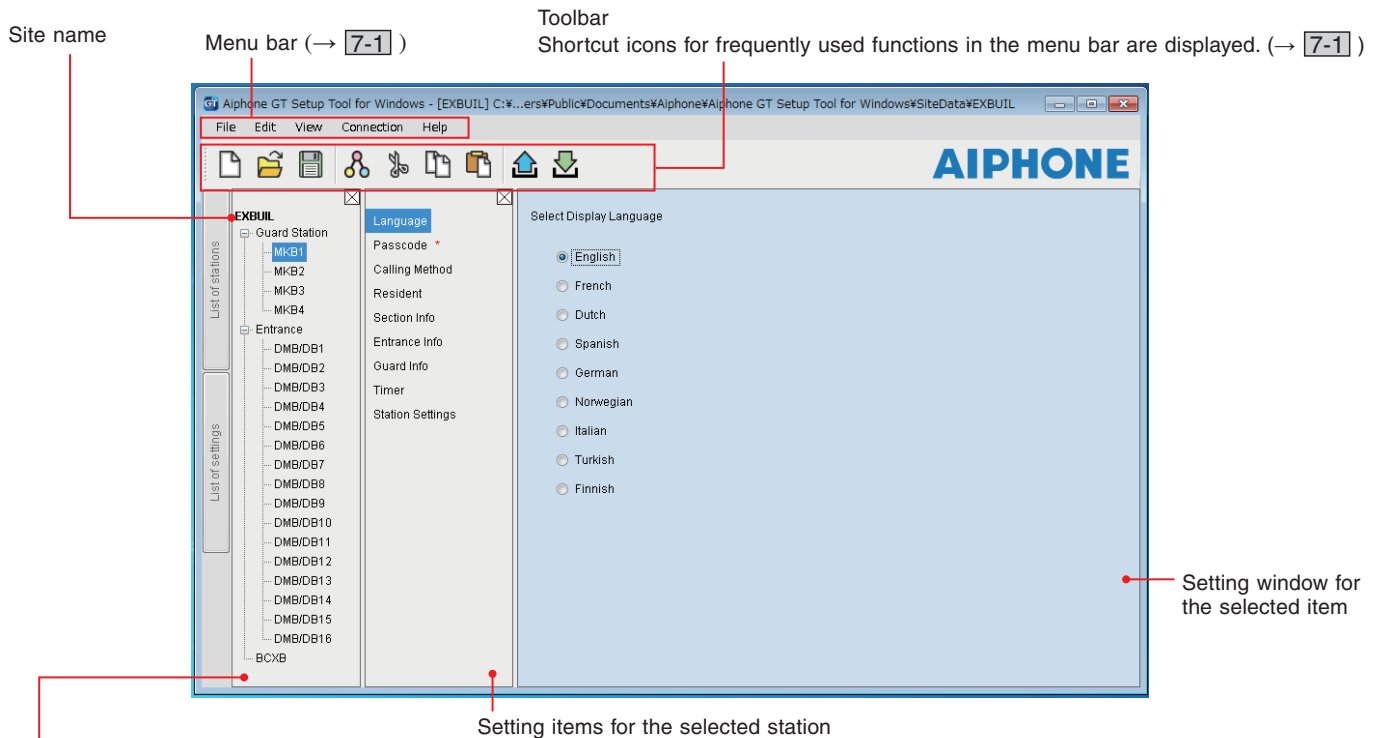

List of stations (*2)

MKB	Guard station [GT-MKB-N]
DMB	Entrance station (all-in-one type) [GT-DMB-N(-LVN)]
DB	Entrance station (modular type) [GT-DB(-V)(-VN)]
BCXB	Expanded bus control unit [GT-BCXB-N]

(*2): The numbers set at "Number of Guards" and "Number of Entrances" in step 4 are assigned to the "Station Names" displayed here starting from "1". The number of "Station Name" can be changed with "Edit" - "Change site configuration" on the toolbar. (→ 7-2)

5-3 Changing the setting contents for an existing site

- 1 Double-click the "Aiphone GT Setup Tool for Windows" icon on the desktop, or run "gt_settingtool.exe".

The "Select an operation" dialog box opens.

- 2 Select "Edit existing site", then click **OK**.

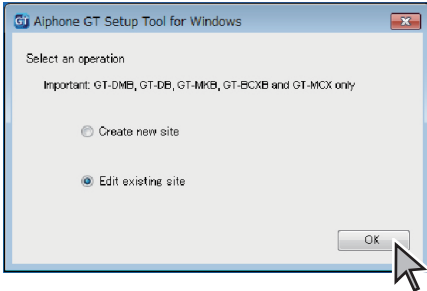

The "Select Site" window opens.

- 3 Set the following items, then click **OK**.

Item	Choices	Note
Setting authorization	Admin/Manager	Admin: Full access to all settings. Manager: Partial access to settings.
Select Site	Select the target site from the pull-down menu.	-

The setting screen for the site opens.

- 4 Change the current setting contents.
(→ **6**)

NOTE:

If the newest setting file is not on the PC, download it from the station, and then change the settings. (→ **7-2**, **7-5**)

6 System settings

Step 2



6-1 Registering resident information

Register information (unit #, resident name, etc.) for each resident.
Follow steps 1 to 3 below.

* The screen below is an example accessed with **Admin** authorization.
(*1): Available only when accessed with the **Admin** authorization.

3 Register resident information.

1 Select a station to edit.

2 Select "Resident".

Select the sorting method of the list.

Enter resident name.

Click to add a resident name to the same unit.
Up to four names can be registered to one unit.

If applicable, assign a call button of the call switch module **GT-SW**. (*1)

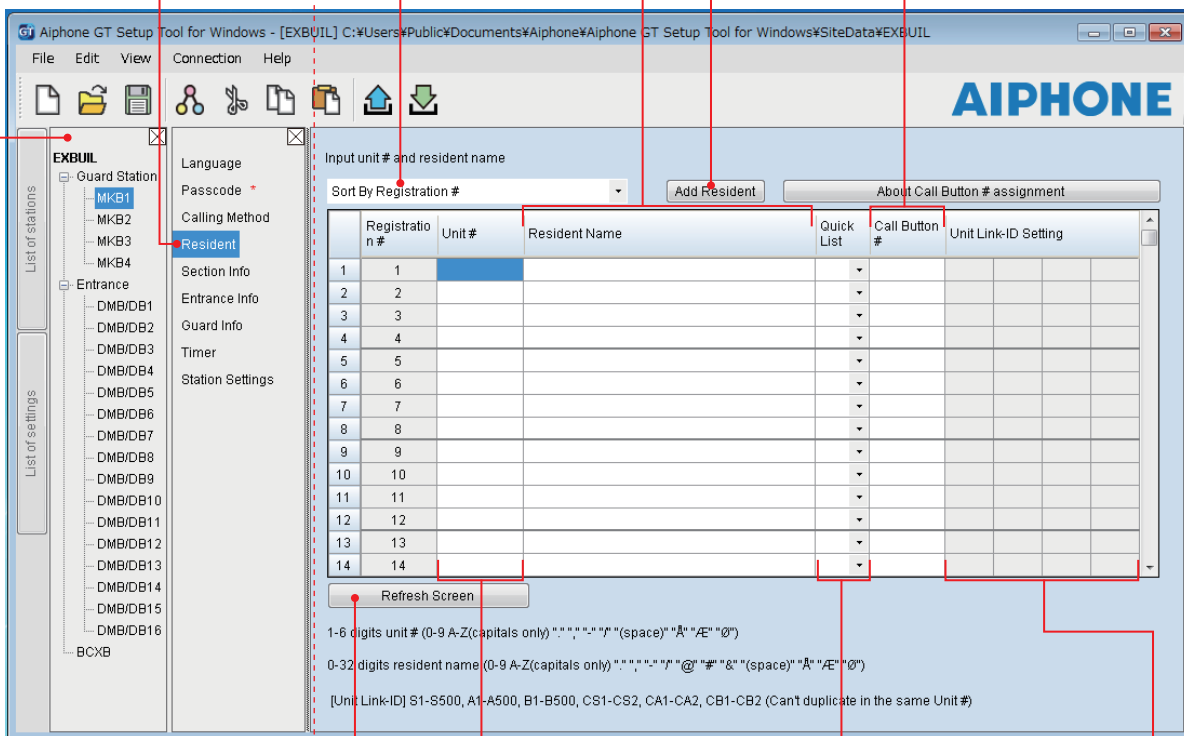

Enter unit #. (*1) **Required**

Add desired resident to the quick list of the entrance station (GT-DMB-N(-LVN)) screen by selecting 1 to 4.

* Up to 4 residents can be added to the quick list. (→ 9-1, 9-3)

* This setting is applied to the "SPEED DIAL" setting of GT-NSB.

Click to refresh the screen.

* When refreshed, the setting of "UNIT Link-ID Setting" is enabled.

Enter the UNIT Link-ID(s) to each residence (unit). (*1)
* Up to 4 UNIT Link-IDs can be linked per residence (unit).
(See below for how to input.)

How to input Link ID

* Refer to "[3] DIP switch settings (confirmation in advance)" for details.

[Standard System]

- For a standard system residential/tenant station, enter S + "UNIT ID". (Input example: S1, S20).
- For a standard system GT-MKB-N, enter CS + "Guard station ID". (Input example: CS1, CS2).

[Expanded System]

CAUTION

Pay attention to the input method for SUB2A/SUB2B line UNIT IDs.

- For an expanded system SUB1A/SUB1B line residential/tenant station, enter A + "UNIT ID". (Input example: A1, A20, A150).
- For an expanded system SUB2A/SUB2B line residential/tenant station, enter B + "250 + UNIT ID". (Input example: B251 when SUB2A/SUB2B line UNIT ID = 1 (250 + 1); B270 when ID = 20 (250 + 20)).
- For an expanded system COMMON1 line GT-MKB-N, enter CA + "guard station ID". (Input example: CA1, CA2).
- For an expanded system COMMON2 line GT-MKB-N, enter CB + "guard station ID". (Input example: CB1, CB2).

6-2 Guard and entrance station settings

Step 3

Configure settings for guard stations and entrance stations individually.
Follow steps 1 to 3 below.

1 Select a station to edit.

2 Select a setting item.
* Refer to the table below for details.

3 Configure the detailed settings.
* Refer to the table below for details.

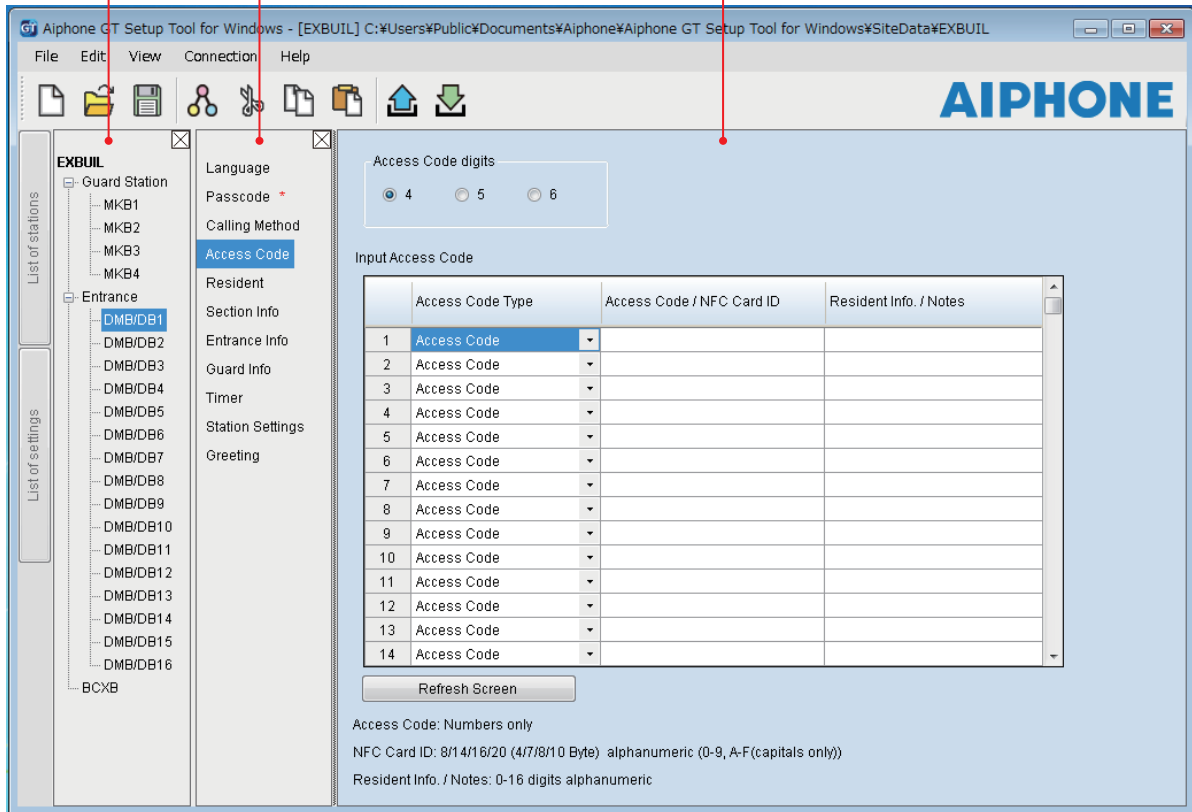

Item	Description	Setting value/choices	Default
Language	Select the screen display language.	English / French / Dutch / Spanish / German / Norwegian / Italian / Turkish / Finnish	English
Passcode Required	Set the passcode for uploading/downloading setting data and accessing the setting mode of each station. NOTE: Do not register the ID of the Android device as the passcode.	-	-
Admin Passcode	Set a passcode for accessing with administrator authorization.	Enter "*" and 4 digits number. ⚠ It is recommended to change the default passcode to a unique one when using the GT Setup Tool for the first time.	*1111
Admin NFC Card ID	Set a NFC Card ID # for accessing with administrator authorization.	8/14/16/20 (4/7/8/10 Byte), alphanumeric (0-9, A-F (capitals only))	-
Manager Passcode	Set a passcode for accessing with manager authorization.	Enter "#" and 4 digits number. ⚠ It is recommended to change the default passcode to a unique one when using the GT Setup Tool for the first time.	#2222
Manager NFC Card ID	Set a NFC Card ID # for accessing with manager authorization.	8/14/16/20 (4/7/8/10 Byte), alphanumeric (0-9, A-F (capitals only))	-
Calling Method Required	Select the method of searching for a unit to call that is available on the search screen.	Name / # Search Section List + Unit # (not applicable) Unit Number (GT-DMB only) Section # + Unit # (not applicable)	Name / # Search

* All items can be set when accessed with the **Admin** authorization.
The items in cannot be set with the **Manager** authorization.

SYSTEM SETUP USING GT SETUP TOOL

Item	Description	Setting value/choices	Default	
Access Code (entrance station only)	Set the door release method (either entering an access code or using NFC) and the access code (or ID) per residence/tenant. NOTE: Do not register the ID of the Android device as the access code.	Access Code digits: 4/5/6	4	
		Access Code Type: Access Code/NFC Card ID	Access Code	
		Access Code: Numbers only (Select 4, 5 or 6 digits.) NFC Card ID: 8/14/16/20 (4/7/8/10 Byte), alphanumeric (0-9, A-F (capitals only))	-	
		Resident Info./Notes: 0-16 digits alphanumeric	-	
Resident	(→ 6-1)	-	-	
Section Info	(For Multi building system only.)	-	-	
Entrance Info	Enter the entrance station information.	<ul style="list-style-type: none"> Section ID: "1" for single building system. Entrance ID: 1-16 Entrance #: 1-6 digits Entrance Name: 0-32 digits 	-	
Guard Info	Enter the guard station information.	<ul style="list-style-type: none"> Section ID: "1" for single building system. Guard ID: 1-4 Guard #: 1-6 digits Guard Name: 0-32 digits 	-	
Timer	Set the duration of each timer operation.	-	-	
Operation Timer	Set the duration of operation.	15-99 sec.	15 sec.	
Program Timer	Set the duration of program mode.	30-99 sec.	60 sec.	
Call Duration	Set the duration of a call.	30-99 sec.	45 sec.	
Station Settings	Configure settings unique for each station.	-	-	
For guard station	Call-In Output	Set whether to make calls to guard stations transferred to the RYC-RYC terminal (ON).	ON / OFF	ON
	Emergency Alarm Output	Set whether to make emergency alarms transferred to the RYK-RYK terminal (ON).	ON / OFF	ON
	Sort method	Set the sorting method for searching.	Sort By Name / Sort By Unit #	Sort By Name
	Video Call Entrance ID	Set the entrance station that can be displayed by pressing the VIDEO CALL button.	N/A Entrance ID1 Entrance ID2	N/A
	Unit Calling	Enable (ON) or disable (OFF) calling a residential/tenant station from a guard station.	ON / OFF	ON
For entrance station	Monitor Setting ^(*) (GT-DMB only)	Enable (ON) or disable (OFF) monitoring an entrance station from a residential/tenant station or guard station.	ON / OFF	OFF
	Camera Display ^(*) (GT-DMB only)	Set the display mode of video during a call.	ZOOM WIDE ZOOM 3s, WIDE WIDE 3s, ZOOM	ZOOM
	Visibility	Enable (ON) or disable (OFF) the backlight adjustment.	ON / OFF	OFF
	Display Unit #	Set whether to show unit # and resident name (ON) or resident name only (OFF) on the entrance station display.	ON / OFF	ON
	Guide Language ^(*) (GT-DMB only)	Set whether to use the voice guidance, and select the language of guidance. • No Guidance: The voice guidance is not used. • Tone: A sound is used instead of the voice guidance.	No Guidance / English / French / Dutch / Spanish / German / Norwegian / Tone	No Guidance
	Sort method	Set the sorting method for searching.	Sort By Name / Sort By Unit #	Sort By Name
	Standby Screen	Set the screen type displayed in standby mode.	Greeting Operation Picture (GT-DMB only) Quick List (GT-DMB only)	Greeting
	Screen Theme (GT-DMB only)	Set the screen background.	A/B	A
	Door Release Timer ^(*) (GT-DMB only)	Set the duration of door release.	0-20 sec. (0 = Momentary)	0=Momentary
	Light or CCTV ^(*) (GT-DMB only)	Select the optional device connected to an entrance station.	Light Control CCTV Switch	Light Control
Camera Priority (GT-DMB only)	Set the priority of cameras.	Internal Camera External Camera	Internal Camera	

* All items can be set when accessed with the **Admin** authorization.
The items in cannot be set with the **Manager** authorization.

(*)1: For a modular type entrance station, this setting can be done only by using the setting switch on the station.

SYSTEM SETUP USING GT SETUP TOOL

Item		Description	Setting value/choices	Default
Station Settings For entrance station	Night Lighting ^{(*)1} (GT-DMB only)	Enable or disable the automatic night lighting function of an entrance station illuminator LED.	Auto Lighting Always Off	Auto Lighting
	Call Button # for Light Control (GT-DB only)	Set one of the call buttons on the GT-SW as the light button.	No entry, 1-100	(No entry)
	Camera Preset	Set the position of camera in the zoom mode.	[1]-[9]	[5]
	Brightness (GT-DMB only)	Adjust the screen brightness.	0-9 (Dark-Bright)	5
Greeting (GT-NSB and GT-DMB only)		-	-	-
	Message	Enter greeting message.	Up to 160 characters	-
	Scroll Speed	Set the scroll speed of the greeting message.	0-9	5
	Lift Control1 (GT-BCXB-N only)	Set the connection for each GTW-LC. * The connection status can be checked by clicking [Check] . <ul style="list-style-type: none"> • Connection • Output Type Select either N.O. (Normally Open) or N.C. (Normally Closed) • Timer Set the timer for enabling lift control. 	<ul style="list-style-type: none"> • Connection: OFF/ON • Output Type: N.O./N.C. • Timer: 1-600 sec. 	OFF - -
	Lift Control2 (GT-BCXB-N only)	Activate relay in corresponding GTW-LC for each resident/tenant station.	1-20	-

* All items can be set when accessed with the **Admin** authorization.
The items in cannot be set with the **Manager** authorization.

(*)1: For a modular type entrance station, this setting can be done only by using the setting switch on the station.

7 Functions in the menu bar

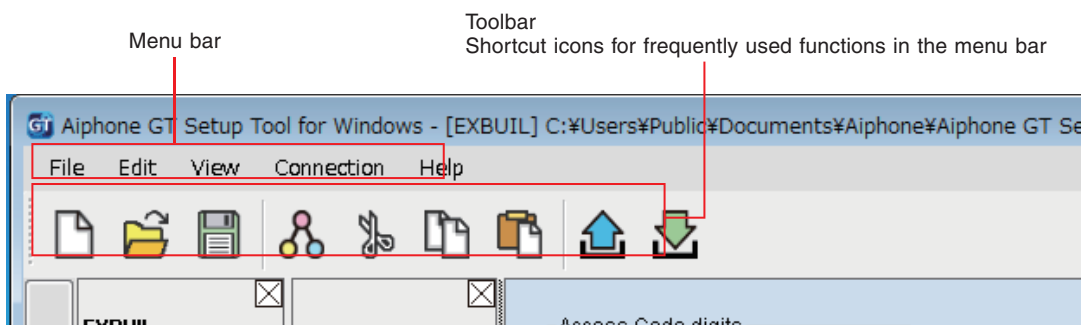

7-1 Function list

Menu	Function	Toolbar icon	Description
File	Create new site		Opens the "Create new site: Site configuration" window. (→ [5-2])
	Edit existing site		Opens the "Select Site" window. (→ [5-3])
	Save Settings		Saves all the setting contents of the current site. (See below.)
	Backup Settings	-	Saves all the setting contents of the current site with a different file name.
	Exit	-	Exits the GT Setup Tool.
Edit	Change site configuration	-	Changes the number of guard stations, entrance stations, expanded bus control unit, and the site name. The number of "Station Name" of each guard station or entrance station can also be changed. (→ [7-2])
	Compare & Merge Settings		The setting contents of two stations or files can be merged by comparing them on the same screen. (→ [7-3])
	Cut		Cuts the selected item or text.
	Copy		Copies the selected item or text.
	Paste		Pastes the copied item or text.
View	Language	-	Selects the screen display language of the GT Setup Tool from the following: English/Français (French)/Nederlands (Dutch)/Español (Spanish)/Deutsch (German)/Norsk (Norwegian)/Italiano (Italian)/Türk (Turkish)/Suomi (Finnish)
	Toolbars	-	Enables/disables the toolbar.
Connection	Upload (PC -> Station)		Setting data configured by the GT Setup Tool can be uploaded to an expanded bus control unit (GT-BCXB-N), entrance stations, and guard stations. (→ [7-4])
	Download (Station -> PC)		Setting data configured on an expanded bus control unit (GT-BCXB-N), entrance stations, and guard stations can be downloaded to the GT Setup Tool. (→ [7-5])
	Upload Picture	-	An image (.gtnb) can be uploaded from the PC to an all-in-one type entrance station GT-DMB-N(-LVN) that is to be displayed on the screen of the GT-DMB-N(-LVN) in standby mode. * An image (.bmp 320 x 240, 24bit) must be converted to a dedicated format (.gtnb) before uploading by using the converter that can be downloaded from the Aiphone website "www.aiphone.net". * Connect a GT-DMB-N(-LVN) to the PC with a USB cable.
	COM Port	-	Sets the COM port of the PC that is used for a USB connection with GT-BCXB-N.
Help	Version	-	Displays the current version of the GT Setup Tool.

Destination of saved files

C:\Users\Public\Documents\Aiphone\Aiphone GT Setup Tool for Windows\SiteData

Style of folder names and file names

	Single building system	Multi building system
Folder name	Site name	Site name
Subfolder name	-	Station (e.g. MCX26)
File name	Station (e.g. DMB1.gtn)	Station (e.g. DMB2.gtn)

7-2 Changing site configuration

1 From the "Edit" menu, select "Change site configuration".

"Change site configuration: (site name)" window appears.

2 Select the stations to add or change the Station name, then click **OK**.

Check the check box of guard stations and entrance stations to use, and uncheck the check box of the stations not to be used.

* In an expanded system, the guard stations and entrance stations connected to the common trunk line 2 of GT-BCXB-N and GT-VBX should be set to the following Station names.

Guard station: MKB3, MKB4
Entrance station: DMB/DB9 to DMB/DB16

Click to change the site name.

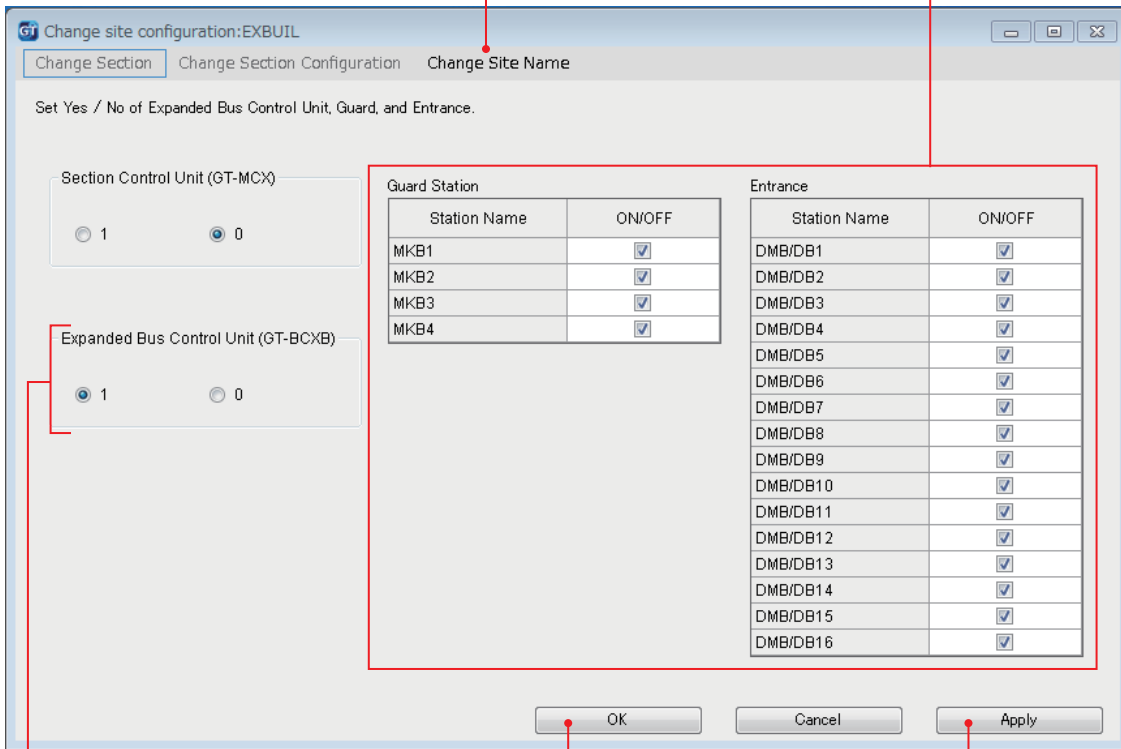

Set whether to use an expanded bus control unit (GT-BCXB)

When using, check "1".
When not using, check "0".

Click to save the changes and close this window.

Click to save the changes and leave this window open.

7-3 Comparing and merging setting contents between stations or files

1 From the "Edit" menu, select "Compare & Merge Settings", or click  on the toolbar.
"Compare & Merge Settings" window appears.

2 Select the stations (or files) to compare as "Comparison-1" and "Comparison-2", then click **Compare**.

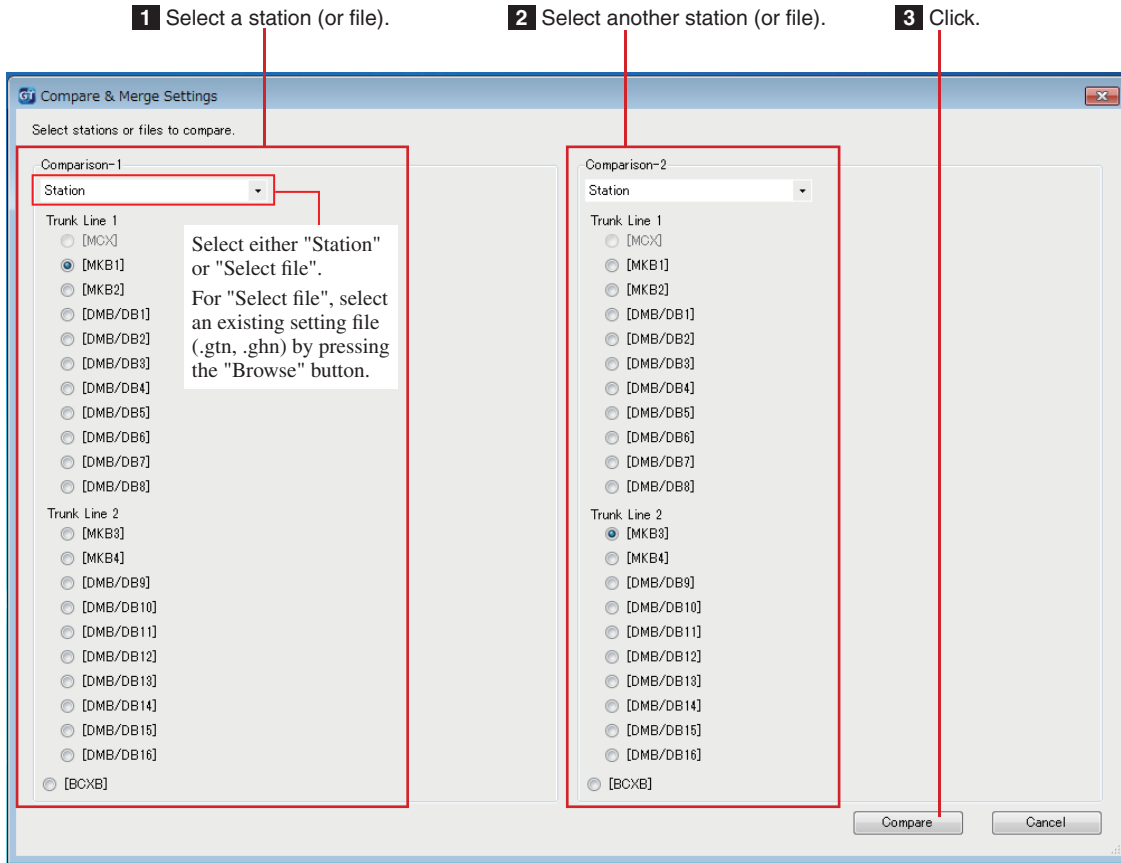

3 Compare the setting contents of the two stations (or files).

The stations (or files) are color-coded red and blue.

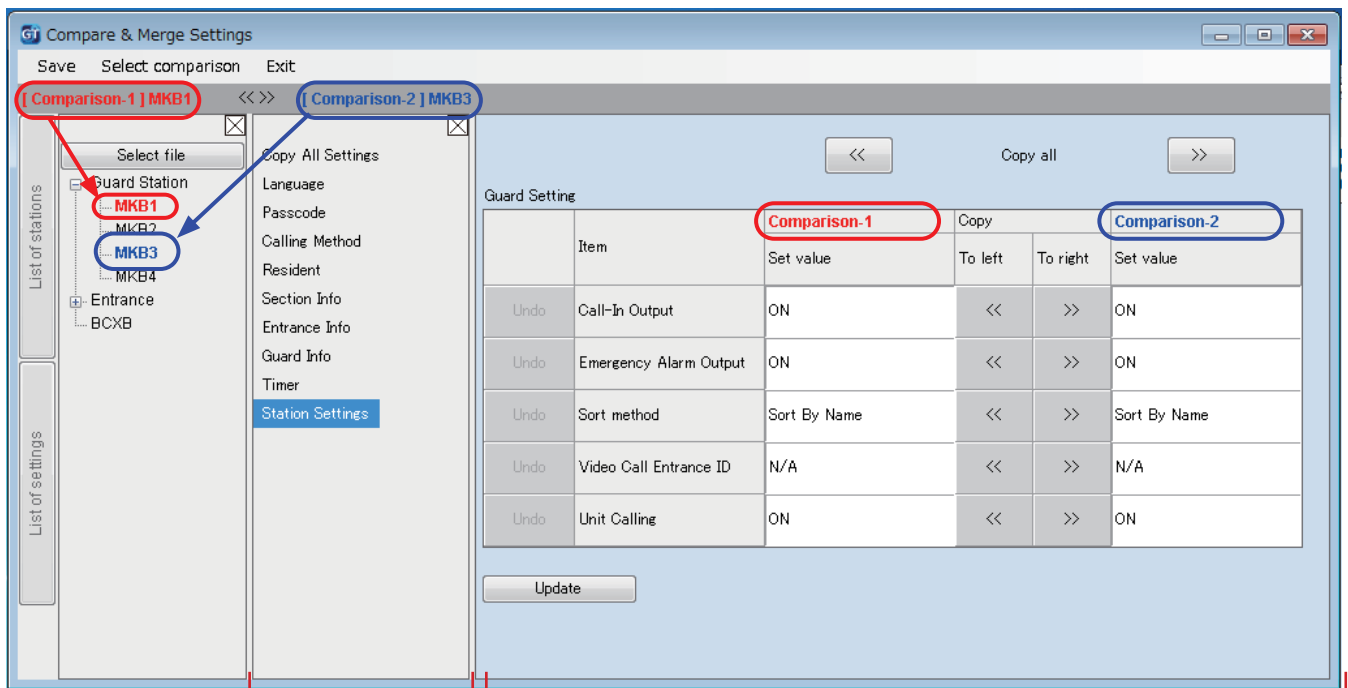

4 If necessary, overwrite the contents of either station (file) with those of the other station (file).

Click to overwrite all contents of "Comparison-1" shown in the list with those of "Comparison-2".

Click to overwrite all contents of "Comparison-2" shown in the list with those of "Comparison-1".

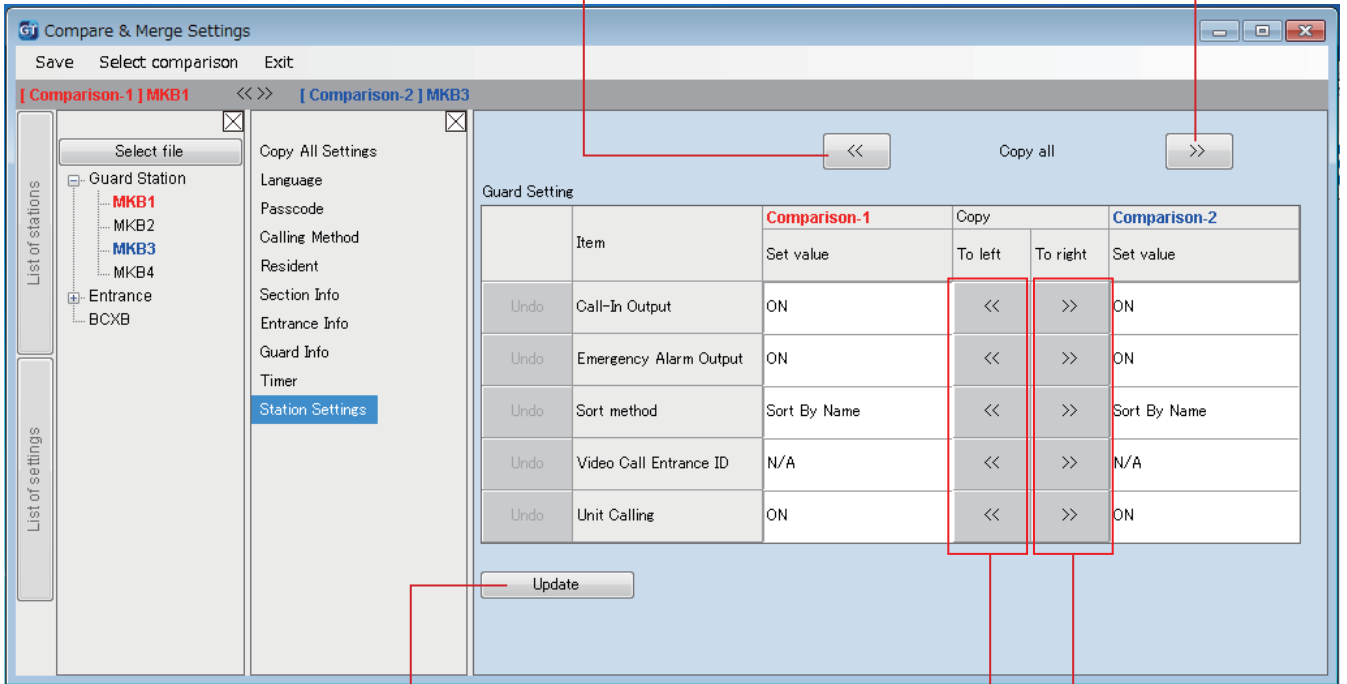

Click to apply the changes in this window. (This operation will not save the changes.)

Click to overwrite the content of "Comparison-1" with that of "Comparison-2" per item.

Click to overwrite the content of "Comparison-2" with that of "Comparison-1" per item.

■ To overwrite all the setting contents of a station (or file) with those of the other station (or file)

1 Click.

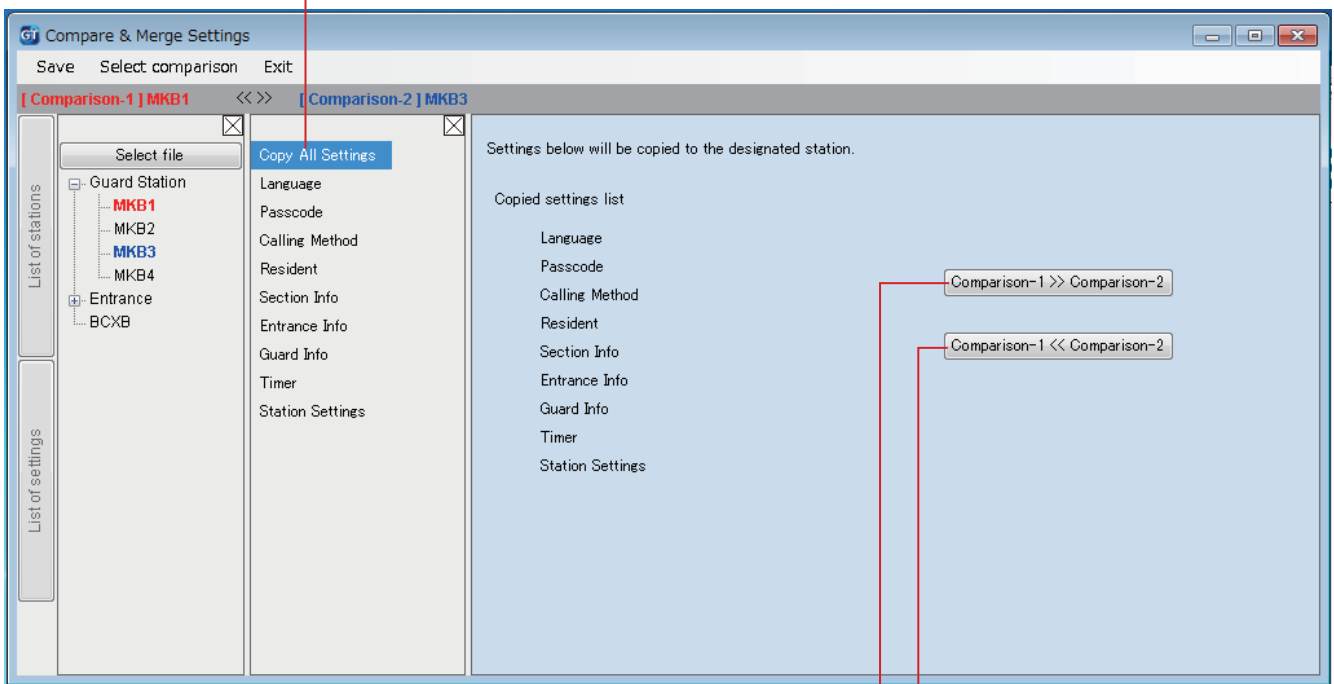

2 Click to overwrite all the setting contents of "Comparison-2" with those of "Comparison-1".

Click to overwrite all the setting contents of "Comparison-1" with those of "Comparison-2".

7-4 Uploading setting data configured by the GT Setup Tool to an entrance station, guard station or expanded bus control unit

1 From the "Connection" menu, select "Upload (PC -> Station)", or click  on the toolbar.
 "Upload (PC -> Station): select communication target" screen appears.

2 Select the target station, then click **OK**.

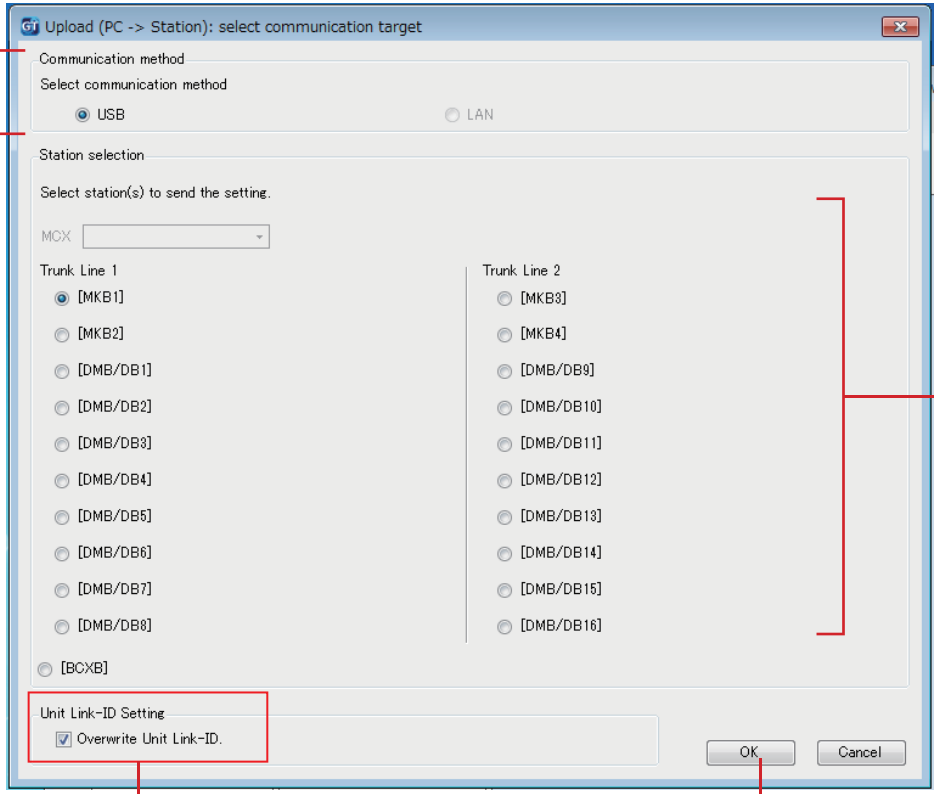

3 Click when updating the Unit Link-ID setting.

4 Click.

 Do not check this box when you will not update the Unit Link-ID setting.

1 Select the communication method with the target station.

When using "USB", connect the PC to the station via the USB terminal on the station.

* Be sure to connect only one station to a PC.

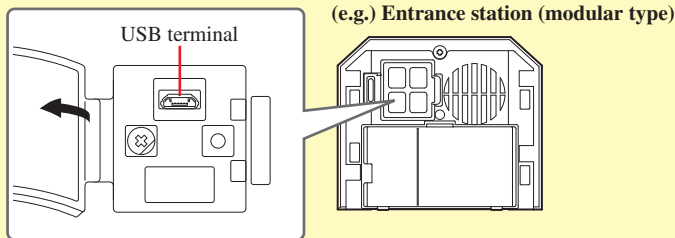

NOTE: Set the "COM Port" setting to the USB terminal number that is used for connecting to GT-BCXB-N. (→ **7-1**)

NOTES:

- When uploading the setting data, entering a passcode is required.
- When "LAN" is selected, data uploading is not possible to an expanded bus control unit GT-BCXB-N.

7-5

Downloading setting data configured on an entrance station, guard station or expanded bus control unit to the GT Setup Tool

- From the "Connection" menu, select "Download (Station -> PC)", or click  on the toolbar.
"Download (Station -> PC): select communication target" screen appears.
- Select the target station, then click **OK**.

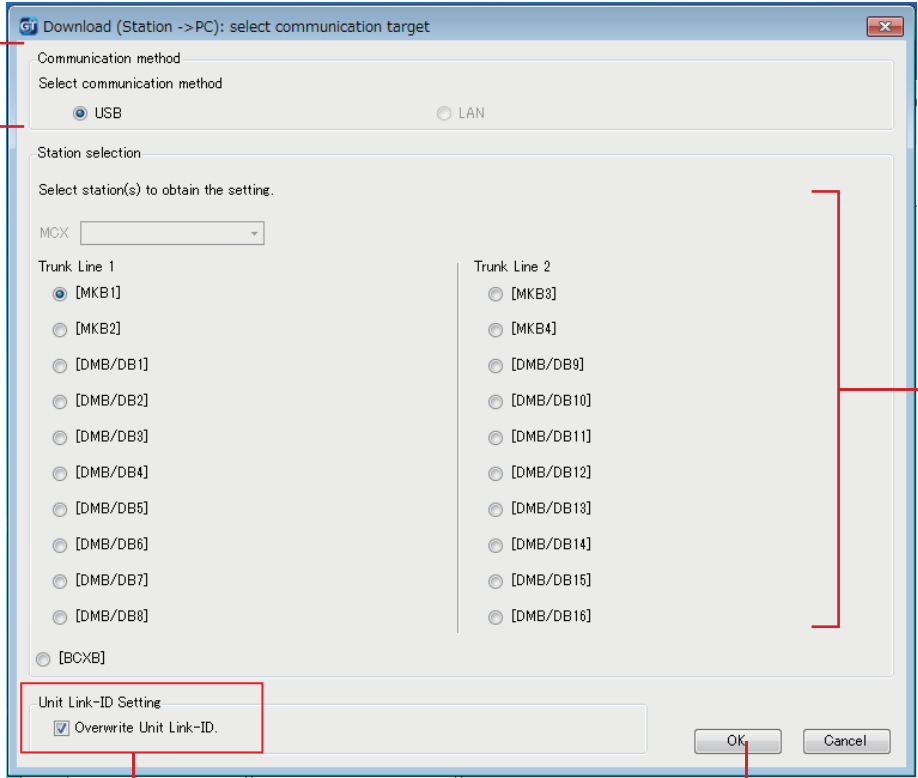

- Click when downloading the Unit Link-ID setting.
 Do not check this box when you will not update the Unit Link-ID setting.
- Click.

1 Select the communication method with the target station.

When using "USB", connect the PC to the station via the USB terminal on the station.
* Be sure to connect only one station to a PC.

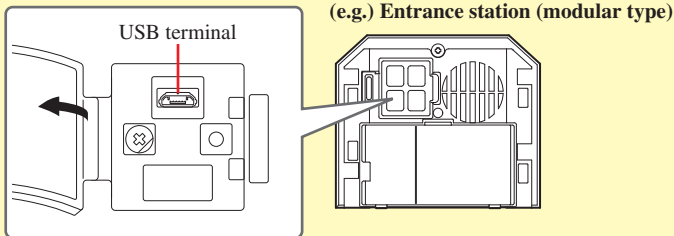

NOTE: Set the "COM Port" setting to the USB terminal number that is used for connecting to GT-BCXB-N. (→ [7-1](#))

NOTES:

- When downloading the setting data, entering a passcode is required.
- When "LAN" is selected, data downloading is not possible from an expanded bus control unit GT-BCXB-N.

SYSTEM SETUP USING ENTRANCE/GUARD STATION

8 Setting up a link among stations

8-1

Setting up a link using a modular type entrance station (GT-DB(-V, -VN)/GT-NSB/GT-SW)



■ Linking residential/tenant stations to the system

- 1 Check that all units are mounted and wired correctly, and then turn on the power.

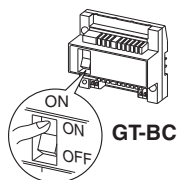

- 2 Remove the front panel and the rubber cap, then use a fine screwdriver to press and release the program switch.

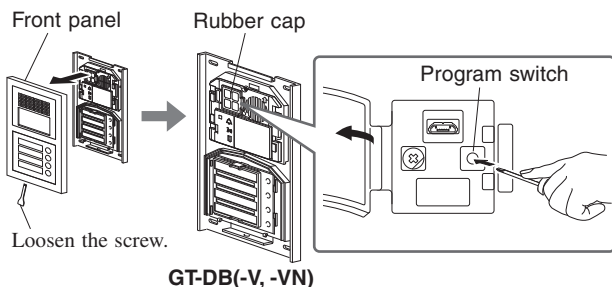

The IN USE LED will flash, and then change to being lit to show that the unit has entered into the programming mode.

- 3 **This step should be done only when doing the link setting to each residential/tenant station for the first time. See "CAUTION".**

When the IN USE LED is lit on the entrance station, press and hold down the [] button while holding down the [GUARD] button on the residential/tenant station.

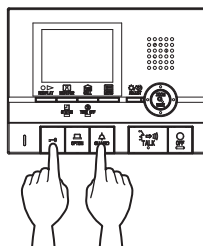

A beep will be emitted approximately 5 seconds later and all of the residence IDs will be deleted.

CAUTION:

Performing this step will delete all link data in the residential/tenant station and return it to the default settings. Perform this step only when configuring the settings the first time after mounting a residential/tenant station. When linking to another guard/entrance station(s), skip this step. When the UNIT Link-ID is set manually with the DIP switch, this operation is not necessary.

- 4 When the IN USE LED is lit on the entrance station, press the [TALK] button of the first residential/tenant station. With the handset type station, lift the handset.

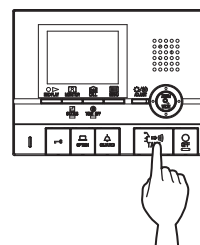

The corresponding communication channel will be established.

- 5 **GT-SW: Press and release the relevant call button.**

* Do not press the button longer than 1 second.

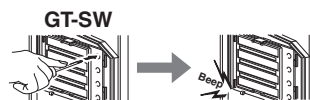

- GT-NSB: Display the assigned unit # and press and release the [] button**

* Do not press the button longer than 1 second.

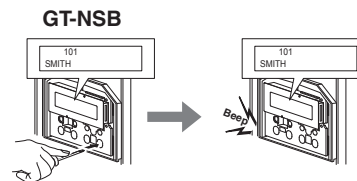

An electronic beep will be emitted once.

Up to 4 stations can be linked to the same unit # (When registering, the electronic beep will be emitted a number of times equal to the number of connected stations.).

* If trying to register the 5th station, an error sound is emitted and the call indicator lights up for 2 seconds.

SYSTEM SETUP USING ENTRANCE/GUARD STATION

- 6** Press the [OFF] button on the residential/tenant station to finish programming. With the handset type station, return the handset.

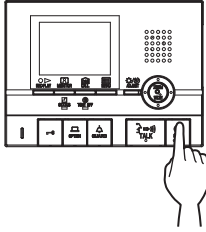

- 7** Repeat steps 3 to 6 to program all residential/tenant stations.

- 8** To quit the programming mode:
Press the program switch of the GT-DB(-V, -VN).

The IN USE LED will go out, and the unit returns to the normal mode.

- ◆ To delete the UNIT Link-ID for each button/unit number in an entrance station

After step 2, operate as follows.

GT-SW: Press and hold the button for the target unit number until the confirmation tone sounds.

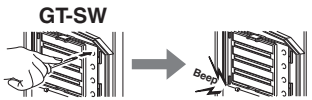

GT-NSB: Display the unit number, then press and hold the [A] button until the confirmation tone sounds.

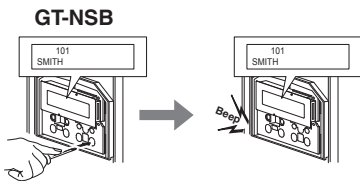

A beep will be emitted for about 3 seconds and the link to the corresponding residential/tenant station will be erased.

■ Transferring link setting data (GT-NSB + GT-10K only)

Transfer link setting data set at an entrance station or guard station to other entrance stations and guard stations.

- 1** In standby mode, press [#], then enter the passcode for Admin authorization.

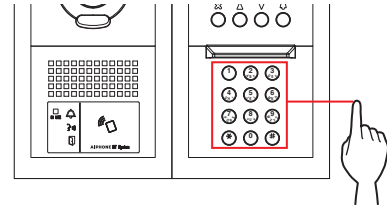

Default passcode (Admin)	*1111
--------------------------	-------

- ⚠ It is recommended to change the default passcode to a unique one when you use this station for the first time.

Alternatively, in standby mode, hold an NFC card registered with the Admin authorization to the station's NFC reader for about 3 seconds.

The station enters the program mode. (Step 2 can be skipped.)

- * When the "ACCESS CODE" is registered to the same NFC card, holding the NFC card to the NFC reader releases the door, and holding the NFC card for about 3 seconds puts the station into the program mode.
- * When the IN USE LED is lit or flashing, the station cannot enter the program mode.

- 2** When "RE-ENTER CODE" is displayed, re-enter the passcode.

The station enters the program mode.

- 3** In the program mode, select "TRANSFER DATA" from the menu, by pressing the [A] or [V] button.

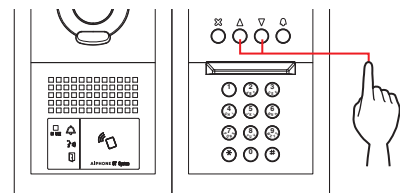

TRANSFER DATA

- 4** Press the [A] button.

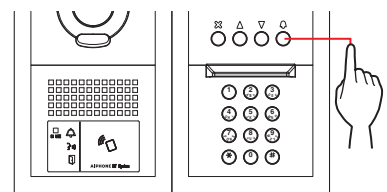

SYSTEM SETUP USING ENTRANCE/GUARD STATION

5 Press the Δ or ∇ button to display either "ENTRANCE" or "GUARD STATION".

- Display "ENTRANCE" to transfer data to an entrance station.
- Display "GUARD STATION" to transfer data to a guard station.

6 Enter the station number of the transfer destination by using the 10-key, then press the \odot button.

Entrance station	1 to 16
Guard station	1 to 4

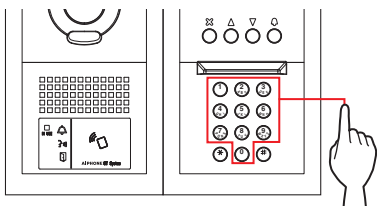

During transfer, "TRANSFERRING..." is displayed.

When transferring has been completed, "DATA TRANSFERRED" is displayed.

■ Verifying link setting

1 Press and hold the program switch of the GT-DB(-V, -VN) for at least 5 seconds.

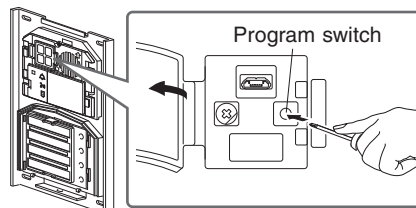

GT-DB(-V, -VN)

The IN USE LED will light up after flashing.

2 GT-SW: Press the relevant button.

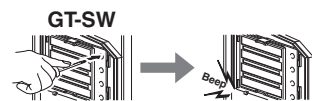

- * Do not hold down the button.

GT-NSB: Display the assigned unit # and press the \odot button.

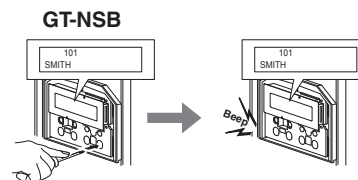

An electronic sound will be emitted once if the link is proper. If the link is improper, a multiple beep sound will be emitted.

- * An error sound will be emitted if communication is failed with at least one of the four residential/tenant stations linked to the call buttons/unit numbers of an entrance station.

3 To quit the program mode: Press the program switch of the GT-DB(-V, -VN).

The IN USE LED will go out, and the unit returns to the normal mode.

8-2

Setting up a link using an all-in-one type entrance station (GT-DMB-N/GT-DMB-LVN)



■ Linking residential/tenant stations to the system

1 Check that all units are mounted and wired correctly, and then turn on the power.

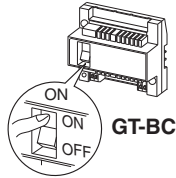

2 In standby mode, press **#**, then enter the passcode for Admin authorization.

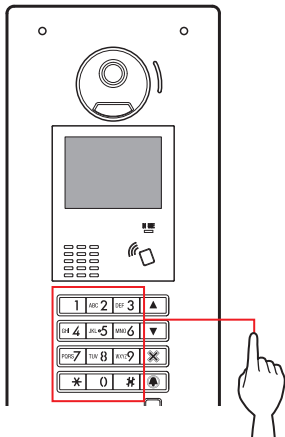

Default passcode (Admin)	*1111
--------------------------	-------

⚠ It is recommended to change the default passcode to a unique one when you use this station for the first time.

Alternatively, in standby mode, hold an NFC card registered with the Admin authorization to the station's NFC reader for about 3 seconds.

The unit enters into the program mode, and the MENU screen is displayed. (Step 3 can be skipped.)

- * When the "ACCESS CODE" is registered to the same NFC card, holding the NFC card to the NFC reader releases the door, and holding the NFC card for about 3 seconds puts the station into the program mode.
- * When the IN USE LED is lit or flashing, the station cannot enter the program mode.

3 When "RE-ENTER CODE" is displayed, re-enter the passcode.

The unit enters into the program mode, and the MENU screen is displayed.

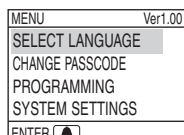

4 In the program mode, select "PROGRAMMING" from the menu by pressing **▲** or **▼**.

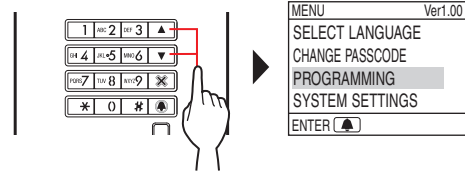

5 Press **ENTER**.

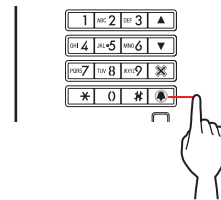

6 Select "PROGRAMMING" from the PROGRAMMING screen by pressing **▲** or **▼**.

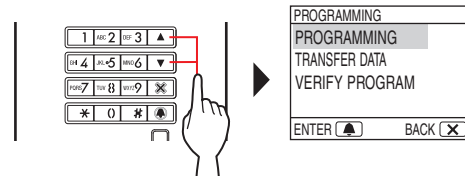

7 Press **ENTER**, and wait until the IN USE LED changes from flashing to staying lit.

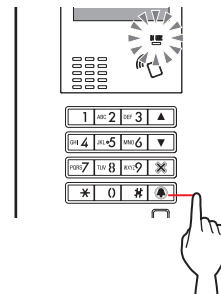

The IN USE LED will flash, and then change to being lit to show that the unit has entered into the programming mode.

- 8** This step should be done only when doing the link setting to each residential/tenant station for the first time. See "CAUTION" below.

When the IN USE LED is lit on the entrance station, press and hold down the [0] button while holding down the [△ GUARD] button on the residential/tenant station.

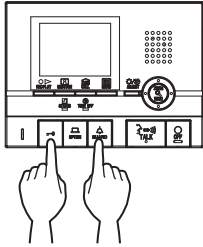

A beep will be emitted approximately 5 seconds later and all of the residence IDs will be deleted.

CAUTION:
Performing this step will delete all link data in the residential/tenant station and return it to the default settings. Perform this step only when configuring the settings the first time after mounting a residential/tenant station. When linking to another guard/entrance station(s), skip this step. When the UNIT Link-ID is set manually with the DIP switch, this operation is not necessary.

- 9** When the IN USE LED is lit on the entrance station, press the [TALK] button of the first residential/tenant station. With the handset type station, lift the handset.

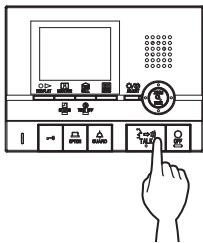

The corresponding communication channel will be established.

- 10** Display the assigned unit # by using the 10-key or [△ / ▽], then press and release [REGISTER].

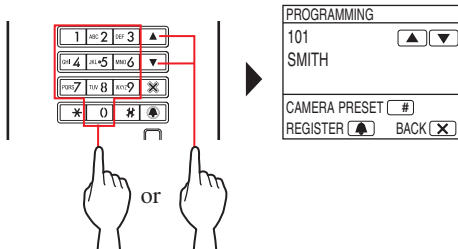

"#n REGISTERD" (n = registration number) will be displayed and an electronic beep will be emitted once.

Up to 4 stations can be linked to the same unit # (When registering, the electronic beep will be emitted a number of times equal to the number of connected stations.).

* If trying to register the 5th station, an error sound is emitted and the error message is displayed.

- 11** Press the [OFF] button on the residential/tenant station to finish programming. With the handset type station, return the handset.

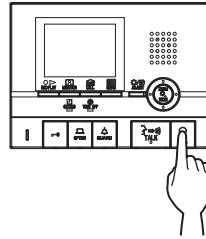

- 12** Repeat steps 8 to 11 to program all residential/tenant stations.

- 13** To quit the programming mode:
Press [X].

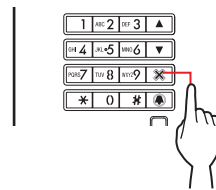

The IN USE LED will go out, and the unit returns to the normal mode.

* During the programming mode, "CAMERA PRESET" mode can be selected by pressing [CAMERA PRESET].

- ◆ To delete the UNIT Link-ID for each button/unit number in an entrance station

After step 10, display the assigned unit #, then press and hold [REGISTER] until the confirmation tone sounds.

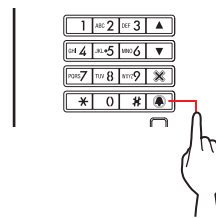

A beep will be emitted for about 3 seconds and the link to the corresponding residential/tenant station will be erased.

■ Transferring link setting data

Transfer link setting data set at an entrance station or guard station to other entrance station and security guard station.

1 In the program mode, select "TRANSFER DATA" from the menu, and press .

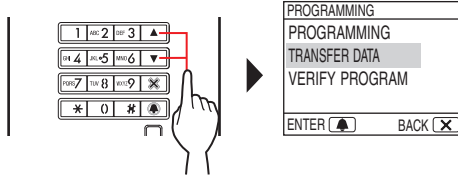

2 Press  /  to display either "ENTRANCE" or "GUARD STATION".

- Display "ENTRANCE" to transfer data to an entrance station.
- Display "GUARD STATION" to transfer data to a guard station.

3 Enter the station number of the transfer destination by using the 10-key, then press .

Entrance station	1 to 16
Guard station	1 to 4

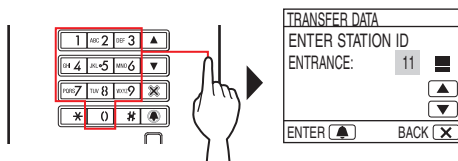

During transfer, "TRANSFERRING..." is displayed and the IN USE LED stays lit.

When transferring has been completed, "DATA TRANSFERRED" is displayed.

■ Verifying link setting

1 In the program mode, select "VERIFY PROGRAM" from the menu, then press .

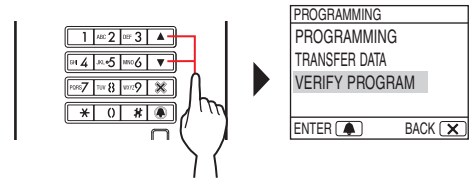

"VERIFYING..." will be displayed.

2 Display the assigned unit # by using the 10-key or  / , then press .

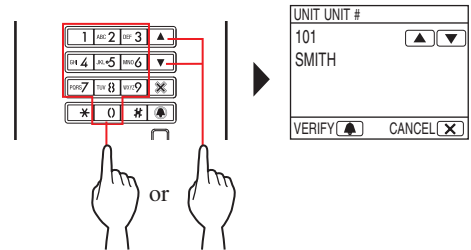

"CORRECT" will be displayed if the link is proper and "ERROR" will be displayed if the link is improper.

8-3 Setting up a link using a guard station (GT-MKB-N)

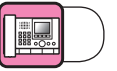

■ Linking residential/tenant stations to the system

1 Check that all units are mounted and wired correctly, and then turn on the power.

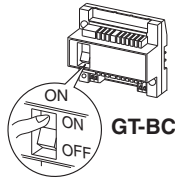

2 In standby mode, press **SETTING**.

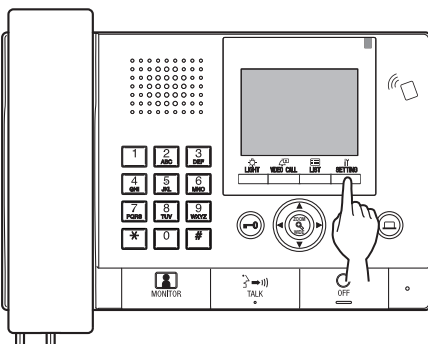

The SETTINGS screen is displayed.

3 Select "ADVANCED SETTINGS"

by pressing **UP** or **DOWN**.

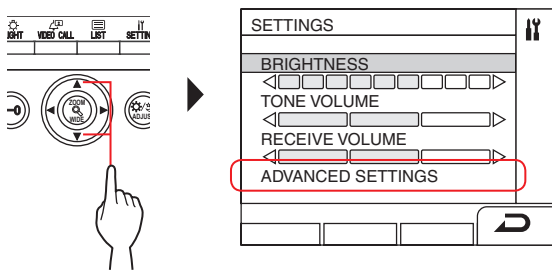

4 Press **LIGHT** (**⊙**) or **ENTER**.

5 Select "PROGRAM MODE"

by pressing **UP** or **DOWN**.

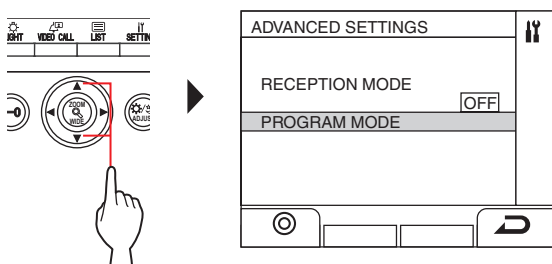

6 Press **LIGHT** (**⊙**) or **ENTER**.

The passcode entry screen is displayed.

7 Enter the passcode for Admin authorization.

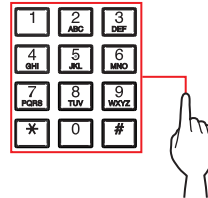

Default passcode (Admin)	*1111
--------------------------	-------

⚠ It is recommended to change the default passcode to a unique one when you use this station for the first time.

Alternatively, in standby mode, hold an NFC card registered with the Admin authorization to the station's NFC reader for about 3 seconds.

The unit enters into the program mode, and the MENU screen is displayed. (Step 8 can be skipped.)

* When the "ACCESS CODE" is registered to the same NFC card, holding the NFC card to the NFC reader releases the door, and holding the NFC card for about 3 seconds puts the station into the program mode.

* When the IN USE LED is lit or flashing, the station cannot enter the program mode.

8 When "RE-ENTER CODE" is displayed, re-enter the passcode.



The unit enters into the program mode, and the MENU screen is displayed.

9 Select "PROGRAMMING" from the MENU screen

by pressing **UP** or **DOWN** and then

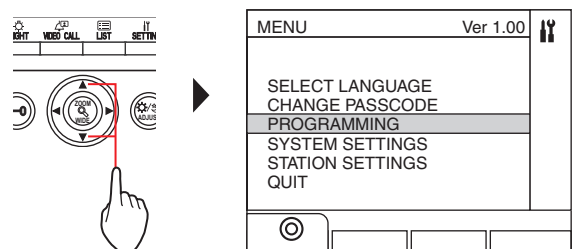
press **LIGHT** (**⊙**).



10 Select "PROGRAMMING" from the PROGRAMMING screen by pressing  or  and then press  ().

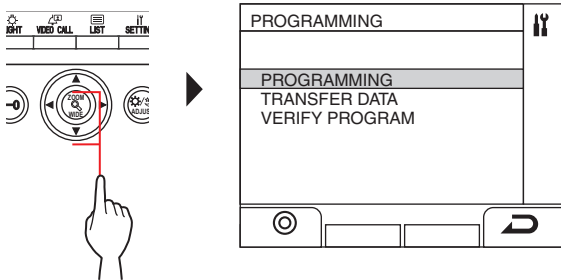

11 Press  () or , and wait until "  " is displayed.

The status LED will flash, and then change to being lit to show that the unit has entered into the programming mode.

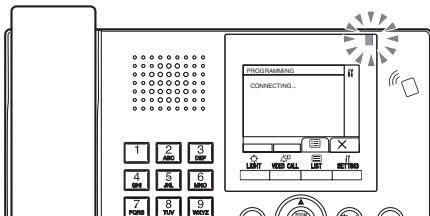

12 This step should be done only when doing the link setting to each residential/tenant station for the first time. See "CAUTION" below.

Press and hold down the [] button while holding down the [ GUARD] button on the residential/tenant station.

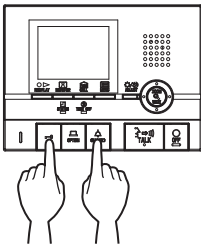

A beep will be emitted approximately 5 seconds later and all of the residence IDs will be deleted.

CAUTION:
Performing this step will delete all link data in the residential/tenant station and return it to the default settings. Perform this step only when configuring the settings the first time after mounting a residential/tenant station. When linking to another guard/entrance station(s), skip this step. When the UNIT Link-ID is set manually with the DIP switch, this operation is not necessary.



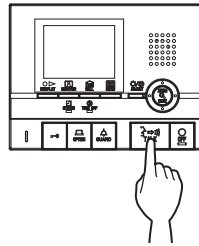

13 Press the [ TALK] button of the first residential/tenant station. With the handset type station, lift the handset.

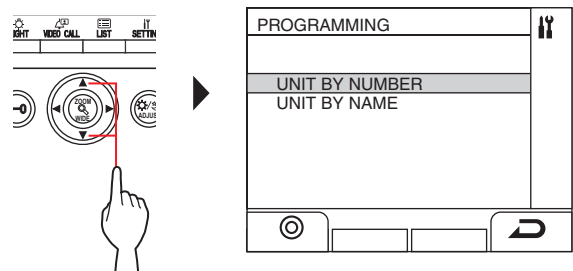

The corresponding communication channel will be established.



14 Select either "UNIT BY NUMBER" or "UNIT BY NAME" by pressing  or .

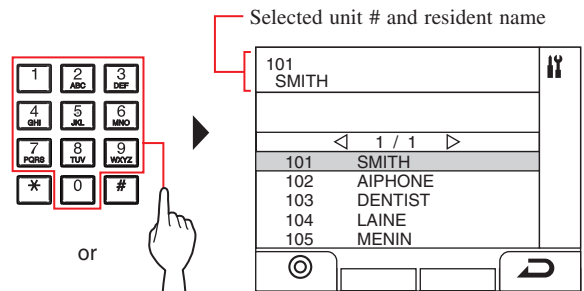

15 Display the assigned unit # by using the 10-key or  / , then press  () or .

* Target unit # can also be displayed by using .



16 Press  () or .

"#n REGISTERD" (n = registration number) is displayed. An electronic beep will be emitted once.

Up to 4 stations can be linked to the same unit # (When registering, the electronic beep will be emitted a number of times equal to the number of connected stations.).

* If trying to register the 5th station, an error sound is emitted and error message is displayed.

- 17** End communication at the residential/tenant station.
- 18** Repeat steps 12 to 17 to program all residential/tenant stations.
- 19** To quit the programming mode:
Press (X).

◆ To delete the UNIT Link-ID for each button/unit number in a guard station

After step 14, press and hold (O) or until the confirmation tone sounds.

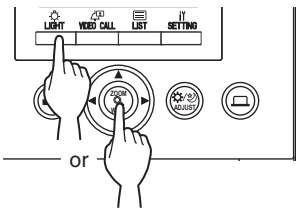

A beep will be emitted and the link to the corresponding residential/tenant station will be erased.

■ Transferring link setting data

Transfer link setting data set at an entrance station or guard station to other entrance stations and guard stations.

- 1** In the program mode, select "TRANSFER DATA" from the menu by pressing or , then press (O) or .

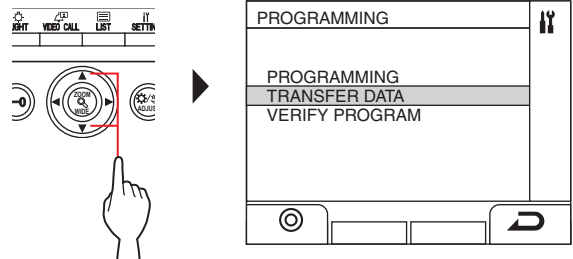

- 2** Enter the entrance station transfer destination by using the 10-key, then press (L) or .

* Press "0" for guard station, and enter guard station transfer destination, then press (L) or .



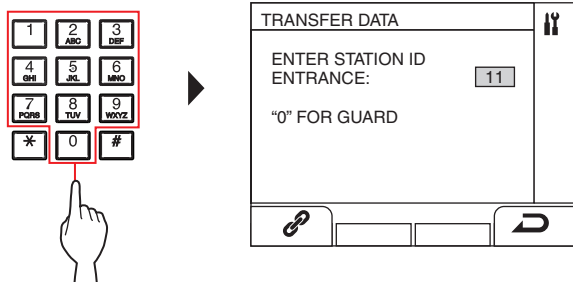

Entrance station	1 to 16
Guard station	1 to 4







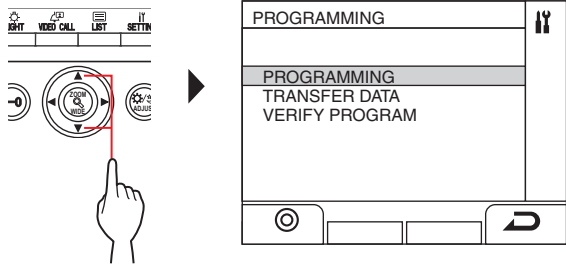

During transfer, "TRANSFERRING..." is displayed.

When transferring has been completed, "DATA TRANSFERRED" is displayed.



■ Verifying link setting

1 In the program mode, select "VERIFY PROGRAM" from the menu by pressing  or , then press  () or .

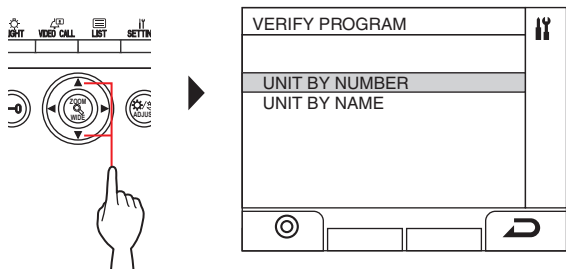

2 Wait until "☰" is displayed, then select the unit searching method (either unit # or resident name) by pressing  or , then press  () or .



3 Display the unit # by using the 10 key, then press  () or .

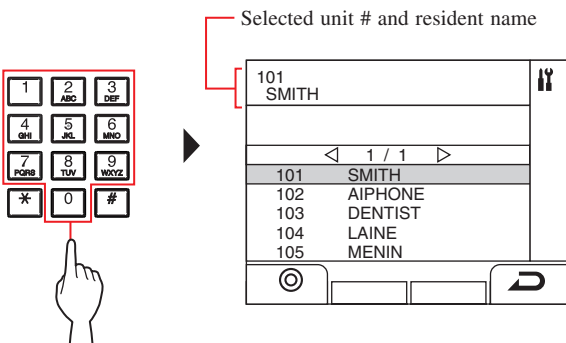

4 Press  () or .

"CORRECT" will be displayed if the link is proper and "ERROR" will be displayed if the link is improper.

9 Station settings





9-1 Setting item list

The following settings can be configured by using an entrance station or guard station. Configurable setting items differ depending on the station type. Also, setting item details and setting methods may differ depending on the station type.

NOTES:

- When any DIP switch setting has been performed, cycle power before performing the following settings. Otherwise, the settings may not be changed.
- The following settings can also be performed by using the GT Setup Tool for Windows or Android Device. Settings that have already been performed by using one of those tools do not need to be set again by using an entrance station or guard station.

Group	Item	Description	Modular type entrance station (GT-NSB) 	All-in-one type entrance station (GT-DMB-N(-LVN)) 	Guard station (GT-MKB-N) 
SELECT LANGUAGE	SELECT LANGUAGE	Select the screen display language.	Required	Required	Required
CHANGE PASSCODE	ADMIN PASSCODE	Set a passcode and NFC ID for entering into the program mode with administrator authorization. NOTE: Do not register the ID of the Android device as the passcode.			
	NUMBER INPUT	Set a passcode.	Required	Required	Required
	NFC CARD	Set an NFC ID.	GT-DB-VN only	✓	✓
	MANAGER PASSCODE	Set a passcode and NFC ID for entering into the program mode with manager authorization. NOTE: Do not register the ID of the Android device as the passcode.			
	NUMBER INPUT	Set a passcode.	Required	Required	Required
	NFC CARD	Set an NFC ID.	GT-DB-VN only	✓	✓
PROGRAMMING	PROGRAMMING	→ 8-2 , 8-3	- (*1)	✓	✓
	CAMERA PRESET	Set the position of camera in the zoom mode.	- (*2)	✓	-
	TRANSFER DATA	→ 8-1 , 8-2 , 8-3	✓	✓	✓
	VERIFY PROGRAM	→ 8-2 , 8-3	- (*1)	✓	✓
SYSTEM SETTINGS	CALLING METHOD	Select the method of searching for a unit to call that is available on the search screen.	-	✓	✓ (*3)
	SECTION INFO (*3)	Information can be entered for each section.			
	SECTION #	Input the section #.	-	✓	✓
	(Section name input)	Input the section name.	-	✓	✓
	RESIDENT INFO	Information can be entered for each resident.			
	UNIT #	Input the unit #.	✓	✓	✓
	(Resident name input)	Input the resident name.	✓	✓	✓
	ENTRANCE INFO	Information can be entered for each entrance station.			
	ENTRANCE #	Input the entrance station #.	-	-	✓
	Entrance Name	Input the entrance station name.	-	-	✓
	GUARD INFO	Information can be entered for each guard station.			
GUARD #	Input the guard station #.	✓	✓	✓	
Guard Name	Input the guard station name.	✓	✓	✓	

✓ : Available - : Not available



* All items can be set when accessed with the **Admin** authorization.
The items in cannot be set with the **Manager** authorization.

(*1): For a modular type entrance station, this setting can be done by using the program switch on the station.

(*2): The item is located at [STATION SETTINGS] - [CAMERA SETTINGS].)

(*3): For a multi building system only

SYSTEM SETUP USING ENTRANCE/GUARD STATION

Group	Item	Description	Modular type entrance station (GT-NSB) 	All-in-one type entrance station (GT-DMB-N(-LVN)) 	Guard station (GT-MKB-N) 
STATION SETTINGS	ACCESS CODE	Set a code and NFC ID for door release. NOTE: Do not register the ID of the Android device as the access code.			
	NUMBER INPUT	Set a number.	✓	✓	-
	NFC CARD	Set an NFC ID.	GT-DB-VN only	✓	-
	TIMER SETTINGS	Set the duration of each timer operation.			
	OPERATION TIMER	Set the duration of operation.	✓	✓	✓
	PROGRAM TIMER	Set the duration of program mode.	✓	✓	✓
	CALL DURATION	Set the duration of call.	✓	✓	✓
	UNLOCK TIMER	Set the duration of door release.	- (*4)	✓	-
	GUIDANCE LANGUAGE	Set whether to use the voice guidance, and select the language of guidance. • No Guidance: The voice guidance is not used. • Tone: A sound is used instead of the voice guidance.	- (*5)	✓	-
	SCREEN SETTINGS (*6)	Configure the settings for screen.			
	SCREEN THEME	Set the screen background.	-	✓	-
	SCROLL SPEED	Set the scroll speed of messages on the display.	✓	✓	-
	BRIGHTNESS	Adjust the screen brightness.	-	✓	✓ (Adjustable by users.)
	SORT SETTINGS	Configure the settings for unit searching.			
	DISPLAY UNIT #	Set whether to show unit # and resident name (ON) or resident name only (OFF).	✓	✓	-
	SORT SETTING	Set the sorting method for searching.	✓	✓	✓
	STANDBY SCREEN	Set the screen type displayed in standby mode.			
	GREETING	Set and change the greeting message to display in standby mode.	✓ (Message is changeable at "CHANGE GREETING".)	✓	-
	OPERATION	Set the call operation method to display in standby mode.	✓	✓	-
	PICTURE	Set the picture to display in standby mode.	-	✓	-
	QUICK LIST	Set resident names (and unit #) to display on the quick list in standby mode.	-	✓	-
	SPEED DIAL	Assign resident name (and unit #) to each of the four call buttons of one GT-SW.	✓	-	-
	MONITOR SETTING	Enable (ON) or disable (OFF) monitoring an entrance station from a residential/tenant station or guard station.	- (*5)	✓	-
	NIGHT LIGHTING	Set whether to use the automatic night lighting function of an entrance station illuminator LED.	- (*7)	✓	-
	CALL BUTTON # FOR LIGHT CONTROL (GT-DB only)	One of the call buttons on the GT-SW can be set as the light button.	- (*1)	-	-

✓ : Available - : Not available

* All items can be set when accessed with the **Admin** authorization.
The items in cannot be set with the **Manager** authorization.

(*1): For a modular type entrance station, this setting can be done by using the program switch on the station.



(*4): For a modular type entrance station, this setting can be done by using the VR1 dial on the station.

(*5): For a modular type entrance station, this setting can be done by using the DIP switch on the station.

(*6): This item title is displayed for all-in-one type entrance station (GT-DMB-N/GT-DMB-LVN) only. Also, the directory structure of this table does not correspond perfectly to the actual display.

(*7): This setting can be done by using the DIP switch on GT-VB.

SYSTEM SETUP USING ENTRANCE/GUARD STATION

Group	Item	Description	Modular type entrance station (GT-NSB) 	All-in-one type entrance station (GT-DMB-N(-LVN)) 	Guard station (GT-MKB-N) 
STATION SETTINGS	CAMERA SETTINGS	Set the use of an entrance station camera.			
	CAMERA DISPLAY	Set the display mode of video during a call.	- (*7)	✓	-
	LIGHT OR CCTV	Select the optional device connected to an entrance station.	- (*7)	✓	-
	CAMERA PRIORITY	Set the priority of cameras.	-	✓	-
	CAMERA PRESET	Set the position of camera in the zoom mode.	✓	✓	-
	VISIBILITY	Preforms backlight adjustment (ON) or not (OFF).	✓	✓	-
	OPTIONAL OUTPUT	Configure the transfer setting for guard stations.			
	CALL-IN OUTPUT	Set whether to make calls to guard stations transferred to the RYC-RYC terminal (ON).	-	-	✓
	ALARM	Set whether to make emergency alarms transferred to the RYK-RYK terminal (ON).	-	-	✓
	UNIT CALLING	Enable/disable calling a residential/tenant station.	-	-	✓
	VIDEO CALL ID	Set the entrance station that can be displayed by pressing the VIDEO CALL button.	-	-	✓
OTHER SETTINGS	RS485 SETTING (*8)	Set RS485 protocol type.	- (*5)	✓	-
	GUIDE VOLUME	Adjust the voice guidance volume.	-	✓	-
VERSION	-	The version of the firmware can be confirmed as in the style below. (e.g.) D:1.00 N:1.00 V:1.00 "D": GT-DB(-V, -VN) "N": GT-NSB "V": GT-VB	✓	- (*9)	- (*9)
QUIT	-	Exit setting.	✓	✓	✓

✓ : Available - : Not available

* All items can be set when accessed with the **Admin** authorization.
The items in cannot be set with the **Manager** authorization.

(*5): For a modular type entrance station, this setting can be done by using the DIP switch on the station.

(*7): This setting can be done by using the DIP switch on GT-VB.

(*8): This setting is needed only in France.

(*9): Displayed on the MENU screen.

9-2 Basic setting operation

Using a modular type entrance station (name scrolling module (GT-NSB)/ 10 key module (GT-10K))



■ Entering program mode

* Settings can be configured only when the unit is in program mode.

1 In standby mode, press **#**, then enter the passcode.

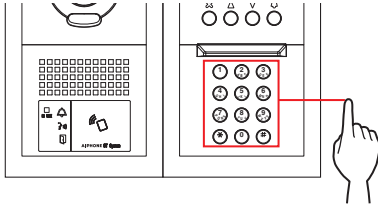

Default passcode

Admin	*1111
Manager	#2222

⚠ It is recommended to change the default passcode to a unique one when you use this station for the first time.

Alternatively, in standby mode, hold an NFC card registered with the Admin/Manager authorization to the station's NFC reader for about 3 seconds.

The unit enters into the program mode, and the first setting item is displayed. (Step 2 can be skipped.)

- * When the "ACCESS CODE" is registered to the same NFC card, holding the NFC card to the NFC reader releases the door, and holding the NFC card for about 3 seconds puts the station into the program mode.
- * When the IN USE LED is lit or flashing, the station cannot enter the program mode.

2 When "RE-ENTER CODE" is displayed, re-enter the passcode.

The unit enters into the program mode, and the first setting item is displayed.

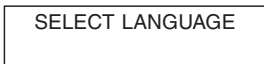

■ Selecting a setting item and change the setting

* Settings can be configured only when the unit is in program mode.

1 In the program mode, press **▲** or **▼** to display the target item.

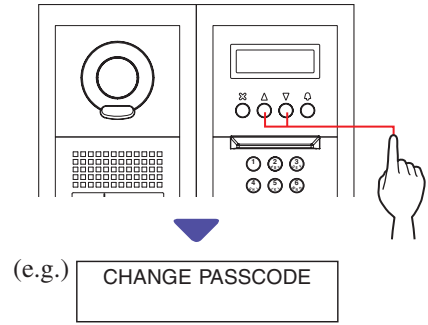

2 Press **Ⓢ**.

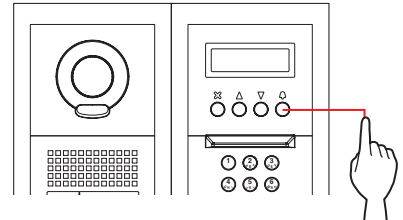

3 Change the setting, by using **▲** / **▼** or 10-key.

* Follow the on-screen instructions.

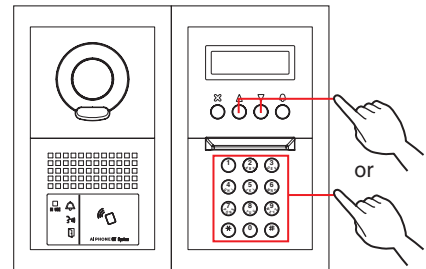

4 Press **Ⓢ** to determine the changed setting.

5 Repeat steps 1 to 4 for changing other item settings.

6 Press **Ⓢ** when "QUIT" is displayed to return to the normal mode.

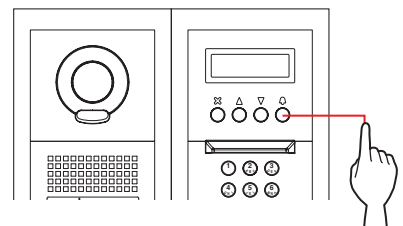

Using an all-in-one type entrance station (GT-DMB-N/GT-DMB-LVN)



■ Entering program mode

* Settings can be configured only when the unit is in program mode.

1 In standby mode, press **#**, then enter the passcode.

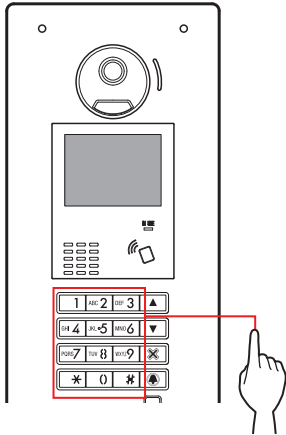

Default passcode

Admin	*1111
Manager	#2222

⚠ It is recommended to change the default passcode to a unique one when you use this station for the first time.

Alternatively, in standby mode, hold an NFC card registered with the Admin/Manager authorization to the station's NFC reader for about 3 seconds.

The unit enters into the program mode, and the MENU screen is displayed. (Step 2 can be skipped.)

- * When the "ACCESS CODE" is registered to the same NFC card, holding the NFC card to the NFC reader releases the door, and holding the NFC card for about 3 seconds puts the station into the program mode.
- * When the IN USE LED is lit or flashing, the station cannot enter the program mode.

2 When "RE-ENTER CODE" is displayed, re-enter the passcode.

The unit enters into the program mode, and the MENU screen is displayed.

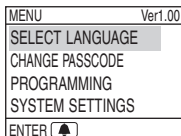

■ Selecting a setting item and change the setting

* Settings can be configured only when the unit is in program mode.

1 In the program mode, press **▲** or **▼** to display the target item.

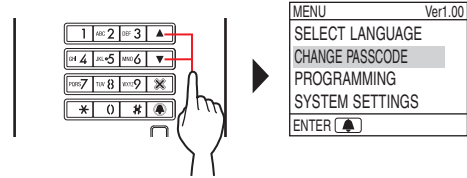

2 Press **ENTER**.

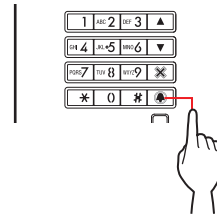

3 Change the setting, by using **▲** / **▼** or 10-key.

* Follow the on-screen instructions.

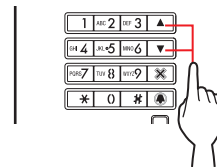

4 Press **ENTER** to determine the changed setting.

5 Repeat steps 1 to 4 for changing other item settings.

6 Press **ENTER** when "QUIT" is displayed to return to the normal mode.

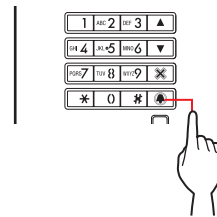

Using a guard station (GT-MKB-N)



■ Entering program mode

* Settings can be configured only when the unit is in program mode.

1 In standby mode, press .

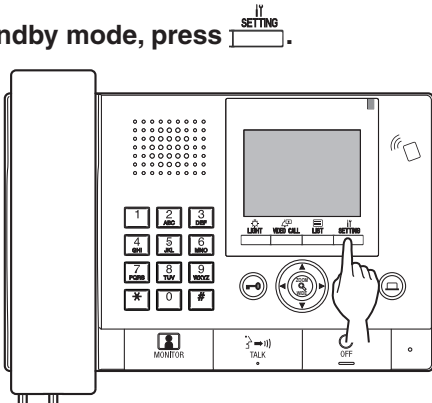

The SETTINGS screen is displayed.

2 Select "ADVANCED SETTINGS"

by pressing or .

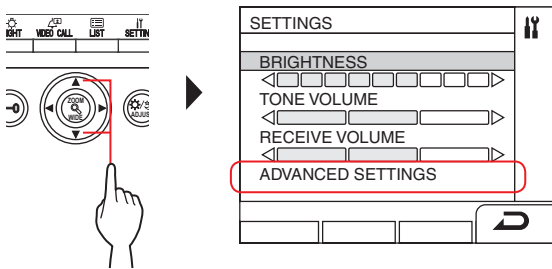

3 Press () or .

4 Select "PROGRAM MODE"

by pressing or .

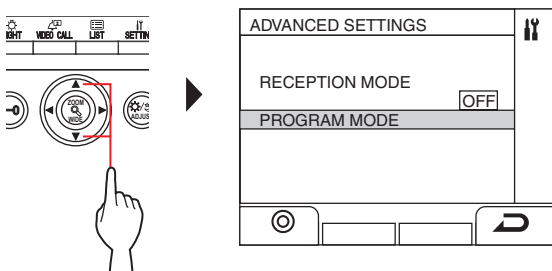

5 Press () or .

The passcode entry screen is displayed.

6 Enter the passcode.

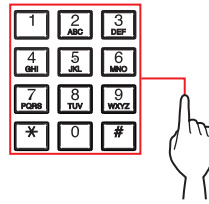

Default passcode

Admin	*1111
Manager	#2222

⚠ It is recommended to change the default passcode to a unique one when you use this station for the first time.

Alternatively, in standby mode, hold an NFC card registered with the Admin/Manager authorization to the station's NFC reader for about 3 seconds.

The unit enters into the program mode, and the MENU screen is displayed. (Step 7 can be skipped.)

- * When the "ACCESS CODE" is registered to the same NFC card, holding the NFC card to the NFC reader releases the door, and holding the NFC card for about 3 seconds puts the station into the program mode.
- * When the IN USE LED is lit or flashing, the station cannot enter the program mode.

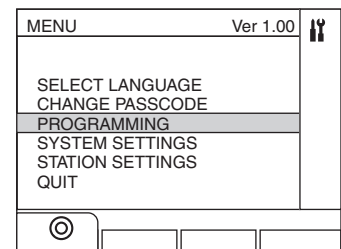

7 When "RE-ENTER CODE" is displayed, re-enter the passcode.

The unit enters into the program mode, and the MENU screen is displayed.





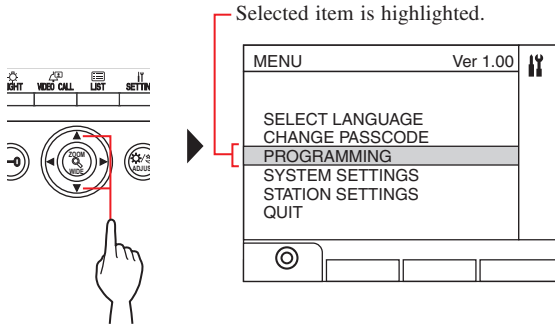

■ Selecting a setting item and change the setting

* Settings can be configured only when the unit is in program mode.

1 In the program mode, press  or  to display the target item.



2 Press  () or .

3 Change the setting, by using  /  or 10-key.

* Follow the on-screen instructions.



4 Press  () or  to determine the changed setting.

5 Repeat steps 1 to 4 for changing other item settings.

6 Press  () when "QUIT" is displayed to return to the normal mode.



How to enter letters for name and greeting message



(e.g.) Entering "CATHY"

1. To enter "C", press "2" three times.
2. [When using an entrance station]: Press  once. (*1)
[When using a guard station]: Press  once. (*1)
3. To enter "A", press "2" once.
4. To enter "T", press "8" once.
5. To enter "H", press "4" twice.
6. To enter "Y", press "9" three times.

(*1): The step is needed for entering different letters with the same key sequentially.

To move cursor

[When using an entrance station]:
Press  to forward, and press  to backward.

[When using a guard station]:
Press  to forward, and press  to backward.

To delete a letter

Press "*" .

To delete all letters after the cursor

Press and hold "*" .





To enter a special character

- , : Press "0" once.
- : Press "0" twice.
- . : Press "0" three times.
- / : Press "0" four times.
- Space : Press five times.
- Æ : Press six times.
- Ø : Press seven times.
- Å : Press eight times.





How to delete "RESIDENT INFO" (Unit #, resident information, and link setting)

1. Enter the program mode with the Admin authorization.
2. Select "SYSTEM SETTINGS".
3. Select "RESIDENT INFO".

Entrance station (GT-DMB, GN-NSB):

4. Display the target resident information entering screen.
5. Press and hold "*" and then press  / .
- "ERASE?" is displayed.
6. Press  /  to delete.

Guard station:

4. Select the target resident.
5. Press "  ()".
"ERASE?" is displayed.
6. Press  () .

9-3 Setting item description

SELECT LANGUAGE



Select the screen display language per station.

Choices:

English/Français (French)/Nederlands (Dutch)/Español (Spanish)/Deutsch (German)/Norsk (Norwegian)/Italiano (Italian)/Türk (Turkish)/Suomi (Finnish)

Default: English

CHANGE PASSCODE



Set a passcode and NFC ID for putting a station into the program mode.

The passcode and NFC ID can be set separately for **Admin** authorization and **Manager** authorization.

⚠ It is recommended to change the passcode before configuring the settings to prevent the set contents from being altered by another person.

Item	Description
NUMBER INPUT (Setting a passcode)	4 digits number only
Compatible NFC card type	Type-A and Type-F

How to register NFC ID to unit

1. Hold an NFC card to the NFC reader on the NFC CARD registration window for about 3 seconds.
2. When the ID is displayed, press the following button.

Entrance station:

Guard station:

"REGISTERED" is displayed to show that the registration is completed.

- * Only one NFC card can be registered for each of Admin and Manager. The same card cannot be registered for both Admin and Manager.
- * When a registered card is used, the current ID is displayed in the NFC card registration window. Following the above steps overwrites the card.

NOTE: Do not register the ID of the Android device as the passcode.

PROGRAMMING

Item	Description
PROGRAMMING	→ 8
CAMERA PRESET	See below.
TRANSFER DATA	→ 8
VERIFY PROGRAM	→ 8

CAMERA PRESET



You can set the position of camera in the zoom mode when a residential/tenant station or guard station is called from an entrance station.

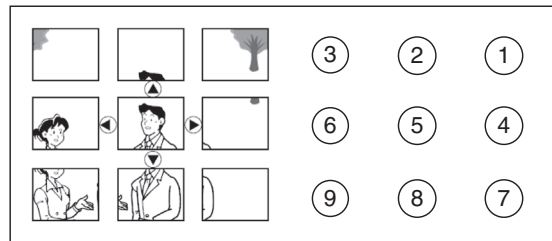

Setting method: Select the desired position number ① to ⑨ by using the 10-key.

Default: Center position [⑤]

- * The setting can be done in the same manner even if the entrance station is in program mode.
- * The same setting can be done at [STATION SETTINGS] - [CAMERA PRESET] (→ P. 46).

NOTE: To change the position that has been set, perform the setting change again. The previous setting will be overwritten.

SYSTEM SETTINGS

■ CALLING METHOD



Select the method of searching for a unit to call that is displayed on the search window.

Choice	Description
NAME / # SEARCH (default)	Searching for a unit from a list or entering a unit # or resident name
SECT LIST+UNIT #	Searching for a section from a list, then a unit by entering a unit # (For a multi building system only)
UNIT NUMBER	Select a unit by entering a unit #
SECT # + UNIT #	Select a section by entering a section #, then a unit # (For a multi building system only)

SYSTEM SETUP USING ENTRANCE/GUARD STATION

SECTION INFO

(For a multi building system only)

Information can be entered for each section.

Item	Description
SECTION #	Enter section #.
	Enter section name etc. * Section name etc. can have up to 32 characters.

RESIDENT INFO

Set a number to each resident and input information for the resident.

Item	Description
UNIT #	Enter unit #.
	Enter resident name etc. * Resident name etc. can have up to 32 characters.

ENTRANCE INFO

Set a number to each entrance station and input information for the entrance station.

Item	Description
ENTRANCE #	Enter entrance station #.
	Enter entrance station name etc. * Entrance station name etc. can have up to 32 characters.

GUARD INFO

Set a number to each guard station and input information for the guard station.

Item	Description
GUARD #	Enter guard station #.
	Enter guard station name etc. * Guard station name etc. can have up to 32 characters.

STATION SETTINGS



ACCESS CODE

Set an access code and NFC ID for door release.

* Up to 500 access codes and NFC IDs can be set at an entrance station.

Item	Description
NUMBER INPUT (Setting an access code)	Numbers only * Select the number of digits from 4, 5 and 6. (Default: 4)
NFC CARD (Setting an NFC ID)	Compatible NFC card type: Type-A and Type-F

How to register NFC ID to entrance station

1. Enter the ACCESS CODE # to be registered in the NFC card registration mode.
2. Press .
3. Hold an NFC card to the NFC reader for about 3 seconds.
4. When the ID is displayed, press .

"REGISTERED" is displayed to show that the registration is completed.

* When a registered card is used, the current ID is displayed in the NFC card registering window. Following the above steps overwrites the card.





NOTE:

Do not register the ID of the Android device as the access code.

SYSTEM SETUP USING ENTRANCE/GUARD STATION

■ TIMER SETTINGS

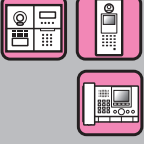
Set the duration of each timer operation.

Item	Description	Setting range
OPERATION TIMER 	If the station is not operated for the set period of time, the system returns to standby mode.	15-99 sec. (Default: 15)
PROGRAM TIMER 	If an operation is not performed for the set period of time in the program mode, the program mode will automatically be cancelled.	30-99 sec. (Default: 60)
CALL DURATION 	Calls from entrance stations and guard stations will expire after the set period of time.	30-99 sec. (Default: 45)
UNLOCK TIMER (*1) 	Set the duration of door release after a door release operation has been performed. * If the timer is set at 00 seconds, the door will be released only while the door release button is pressed and held.	00-20 sec. (Default: 00)

■ GUIDANCE LANGUAGE (*2)

Set whether to use the voice guidance that will be heard when a call is received, etc., and select the language of guidance.

Choices:



No Guidance/English/Français (French)/Nederlands (Dutch)/Español (Spanish)/Deutsch (German)/Norsk (Norwegian)/Tone

Default: No Guidance

- No Guidance: The voice guidance is not used.
- Tone: A sound is used instead of the voice guidance.



■ SCREEN SETTINGS

Configure the settings for screen.

Item	Description	Setting range
SCREEN THEME 	Set the background image of the screen.	A/B (Default: A)
SCROLL SPEED 	Set the scroll speed of messages on entrance station display.	SLOW 0-9 FAST (Default: 5)
BRIGHTNESS (*3) 	Adjust the screen brightness.	DARK 0-9 BRIGHT (Default: 5)

■ SORT SETTINGS

Configure the settings for unit searching.

Item	Description	Choices
DISPLAY UNIT # 	Set whether to show unit # and resident name (ON) or resident name only (OFF) on the entrance station display.	ON/OFF (Default: ON)
SORT SETTING 	Set the sorting method for searching. Select either name order or unit # order for searching at entrance stations and guard stations.	SORT BY NAME SORT BY UNIT # (Default: SORT BY NAME)

(*1): For a modular type entrance station, this setting can be done by using the VR1 dial on the station.

(*2): For a modular type entrance station, this setting can be done by using the DIP switch on the station.

(*3): For a guard station, this setting can be done by users.

■ **STANDBY SCREEN** 

Set the screen type displayed in standby mode.





Item	Description	Setting range
STANDBY SCREEN	<p>Set the screen type in standby mode from the following.</p> <ul style="list-style-type: none"> • GREETING: Greeting message * The greeting message can be changed by using up to 160 characters. * For GT-DB(-V, -VN), the greeting message can be changed at "CHANGE GREETING". • OPERATION: Operation screen • PICTURE (GT-DMB only) * Upload an picture by using a PC. • QUICK LIST (GT-DMB only) * When QUICK LIST is selected, configure the setting of "QUICK LIST". 	<p>GREETING/ OPERATION/ PICTURE/ QUICK LIST (Default: GREETING)</p>
QUICK LIST	<p>Set resident names (and unit #) to display on the quick list in standby mode.</p>	-

■ **SPEED DIAL** 

Available on a GT-NSB connected with a GT-SW. A resident name (and unit #) can be assigned to a call button of GT-SW. Residents can be assigned to up to four call buttons.

Assigning method

[When using GT-NSB]

1. Select [STATION SETTINGS] → [SPEED DIAL] in the program mode.
2. Enter the number of call button to which you will assign a resident, then press .
 - * When no resident is assigned, "NO ASSIGNMENT" is displayed. If already assigned, the resident information is displayed.
3. Search for a desired resident by the following methods.
 - (a) **Searching by resident name:**
Press .
"ENTER A LETTER" is displayed, and searching by resident name is enabled.
 - (b) **Searching by UNIT #:**
Press  when "ENTER A LETTER" is displayed.
"ENTER A UNIT #" is displayed, and searching by UNIT # is enabled.
* To return to the search method (a), press .
4. Display a desired resident information, then press .

The selected resident has been assigned.

[When using the GT Setup Tool]

Do the setting of [Resident] → [Quick List].

It is applied to the setting of "SPEED DIAL".

■ **MONITOR SETTING** (*2) 

Enable (ON) or disable (OFF) monitoring an entrance station from a residential/tenant station or guard station.

Default: OFF

(*2): For a modular type entrance station, this setting can be done by using the DIP switch on the station.

■ NIGHT LIGHTING (*4) 

Set whether to use the automatic night lighting function of an entrance station illuminator LED.

Choice	Description
AUTO LIGHTING (default)	At night, the illuminator LED automatically lights up on an entrance station during calling from an entrance station.
ALWAYS OFF	The illuminator LED on an entrance station is always off.

■ CALL BUTTON # FOR LIGHT CONTROL 

One of the call buttons on the GT-SW can be set as the light button.

* This function is not available when GT-NSB is connected to the station.

Setting method

* In advance, set the DIP switch No. 2 of SW1 on GT-VB to "OFF".

1. Remove the front panel and the rubber cap, then use a fine screwdriver to press and release the program switch.

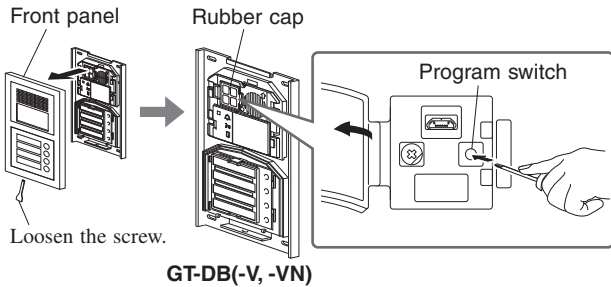

2. Press and release the relevant call button while the IN USE LED is flashing.

* Do not press the button longer than 1 second.

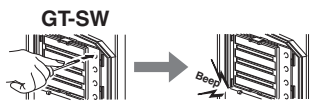

An electronic beep will be emitted once.







How to use

Press the call button assigned as the light button to light up the light connected to the entrance.



■ CAMERA SETTINGS

Set the use of an entrance station camera.

Item	Description	Setting range
CAMERA DISPLAY (*4) 	Select the display mode of video during a call from the following. <ul style="list-style-type: none"> • ZOOM Zoom mode only • WIDE Wide mode only • ZOOM 3S >> WIDE Zoom mode in 3 seconds, then switched to wide • WIDE 3S >> ZOOM Wide mode in 3 seconds, then switched to zoom 	ZOOM/ WIDE/ ZOOM 3S >> WIDE/ WIDE 3S >> ZOOM (Default: ZOOM)
LIGHT OR CCTV (*4) 	Select the optional device connected to an entrance station that turns on when the light button on a residential/tenant station is pressed. <ul style="list-style-type: none"> • LIGHT CONTROL Select this when a light is connected. • CCTV SWITCH Select this when a surveillance camera is connected. 	LIGHT CONTROL/ CCTV SWITCH (Default: LIGHT CONTROL)
CAMERA PRIORITY 	Set the camera priority when a residential/tenant station is called from an entrance station. <ul style="list-style-type: none"> • INTERNAL CAMERA The camera built into the entrance station. • EXTERNAL CAMERA A surveillance camera etc. connected to the entrance station. 	INTERNAL CAMERA/ EXTERNAL CAMERA (Default: INTERNAL CAMERA)
CAMERA PRESET  	You can set the position of camera in the zoom mode when a residential/tenant station is called from an entrance station. Select the desired position number ① to ⑨ by using the 10-key. (→P. 42)	(Default: Center position [⑤])
VISIBILITY  	When an entrance station is installed at a location where backlighting makes viewing difficult, set this item to ON. The visibility may be improved. * This feature is applied to the daytime only.	ON/OFF (Default: OFF)

(*4): This setting can be done by using the DIP switch on GT-VB.

Setting CAMERA PRESET using a residential/tenant station (for stations with a zoom/wide function only)



Setting method

1. Put an entrance station into the programming mode.
2. Start communication from a residential/tenant station to display the picture at the currently-set zoom position.
3. Adjust the camera zoom position using the [▲], [▼], [◀], and [▶] buttons on the residential/tenant station.
4. Press and hold the [ZOOM/WIDE] button (for at least 2 seconds).
A beep will sound and the position setting will be completed.
5. End residential/tenant station communication.
6. Exit the programming mode from the entrance station.

- * Pressing the entrance station call button will set a link with the residential/tenant station, but preset settings cannot be performed.
- * The position set at one entrance station will be applied to all linked residential/tenant stations.

NOTES:

- To change the zoom position that has been set, set the CAMERA PRESET again. The previous setting will be overwritten.
- The set zoom position will also be applied to the sub residential/tenant station. The CAMERA PRESET cannot be set using a sub residential/tenant station.

OPTIONAL OUTPUT



Configure the transfer setting for guard stations.

Item	Description	Choices
CALL-IN OUTPUT	Set whether to make calls to guard stations transferred to the RYC-RYC terminal (ON).	ON/OFF (Default: ON)
ALARM	Set whether to make emergency alarms transferred to the RYK-RYK terminal (ON).	ON/OFF (Default: ON)

UNIT CALLING



Enable/disable calling a residential/tenant station.

VIDEO CALL ID



Set the entrance station that can be displayed by pressing the **VIDEO CALL** button.

Choices:

- N/A
- ENTRANCE ID 1
- ENTRANCE ID 2

Default: N/A

OTHER SETTINGS



RS485 SETTING

* This setting is needed only in France.

Set RS485 protocol type. Select either "AIPHONE" or "HEXACT®".

Choices:

- AIPHONE
- HEXACT®

GUIDE VOLUME

Guidance volume can be adjusted.

Setting range: LOW 1 to 3 HIGH

Default: 2

SETTINGS ON RESIDENTIAL/TENANT STATION

10 Changing settings on GT-2C-L/GT-2C only

NOTES:

- See the operation manual included with the GT-2C-L/GT-2C for the name and operating method for each part.
- Actual screens may vary depending on the system.
- When settings are changed, turn the unit power supply off and on again. Otherwise, the settings may not be changed.

10-1 How to use the MENU

- 1** In standby mode, press the [⚙️ ADJUST] button and [🔍 ZOOM/WIDE] button until the warning screen displays. Press the [☰ MENU] button in accordance with the warning screen.

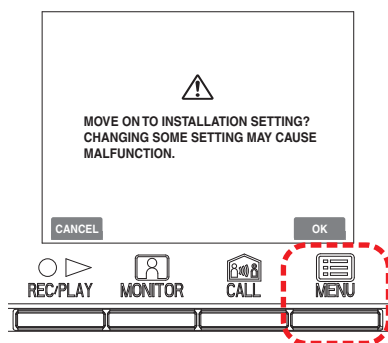

- 2** Press the [▲], [▼], [◀], and [▶] buttons in the "INSTALLATION" screen to select the item to be set and confirmed, and press the [☰ MENU] button.

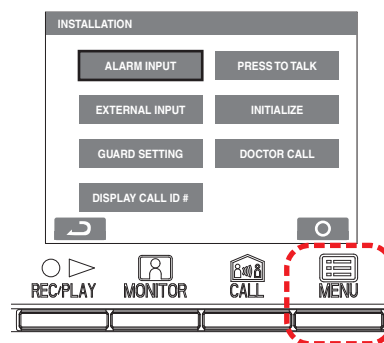

- 3** To finish changing settings, press the [○ OFF] button to return to the standby mode. In other cases, set by pressing the [☰ MENU] button. Press the [○▶ REC/PLAY] button to cancel the settings and return to the previous screen.

10-2 Guard station settings

Change the names of the guard stations that display with the GT-2C-L/GT-2C.

- 1** After performing steps 1 in section [10-1](#), select "GUARD SETTING" in the "INSTALLATION" screen and press the [☰ MENU] button.

- 2** In the "GUARD SETTING" screen, make a selection from "GUARD1" to "GUARD4" and press the [☰ MENU] button.

Select from "GUARD/CONCIERGE/RECEPTION/NOT DISPLAYED" for each. Press the [☰ MENU] button to complete the settings.

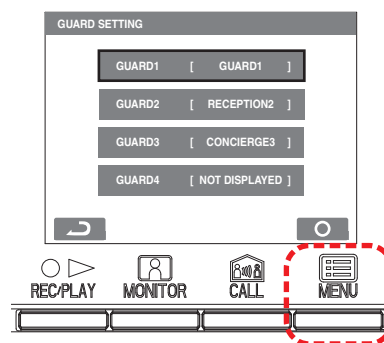

10-3 Emergency input settings

Set emergency input to be enabled or disabled.

- 1 After performing steps 1 in section 10-1, select "ALARM INPUT" in the "INSTALLATION" screen and press the [MENU] button.

- 2 Select "DISABLE", "N/O", or "N/C" in the "ALARM INPUT" screen. Press the [MENU] button to complete the settings and return to the previous screen.

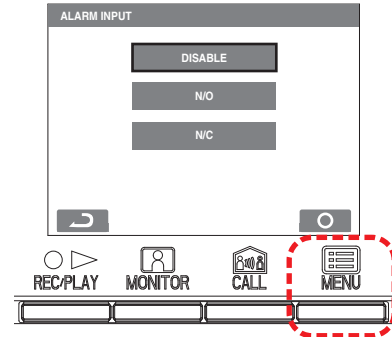

10-4 External input setting

Set external input (3 circuits) to security sensor or utility sensor.

- 1 After performing steps 1 in section 10-1, select "EXTERNAL INPUT" in the "INSTALLATION" screen and press the [MENU] button.
- 2 In the "EXTERNAL INPUT SETTING" screen, make a selection from "SENSOR1" to "SENSOR3" and press the [MENU] button.

- 3 Select from "DISABLE/UTILITY/SECURITY" in each screen from "SENSOR1 SETTING" to "SENSOR3 SETTING" and then press the [MENU] button.

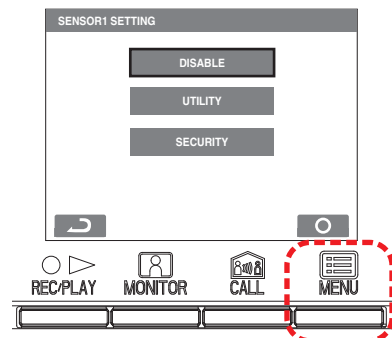
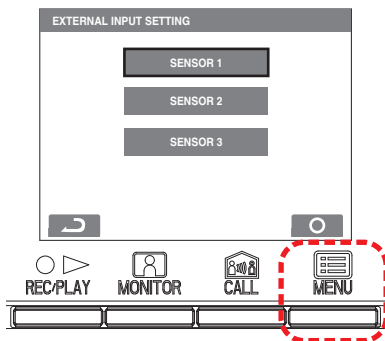

SETTINGS ON RESIDENTIAL/TENANT STATION

Utility sensor setting (detection method)

- 4 When "UTILITY" is selected, select "N/O" or "N/C" in the "UTILITY-SENSOR DETECTION METHOD" screen and press the [MENU] button.

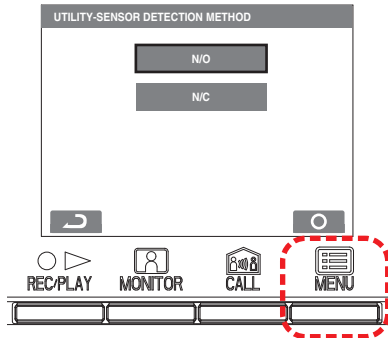

Security sensor setting (detection method)

- 4 When "SECURITY" is selected, select "N/O" or "N/C" in the "SECURITY-SENSOR DETECTION METHOD" screen and press the [MENU] button.

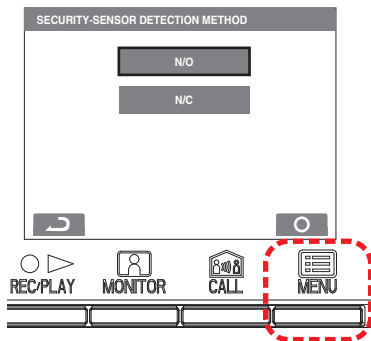

Security sensor (alarm transfer)

- 5 When [SECURITY] is selected, in the [EXTERNAL INPUT SETTING] screen, select [ALARM TRANSFER] and press the [MENU] button.

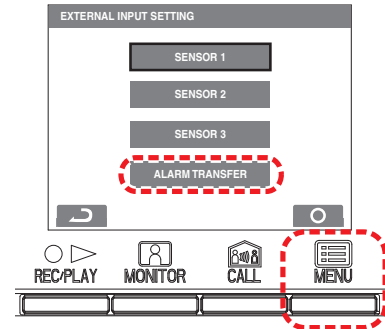

- 6 Select from "ENABLE/DISABLE" in the "SECURITY ALARM TRANSFER" screen. Press the [MENU] button to complete the settings.

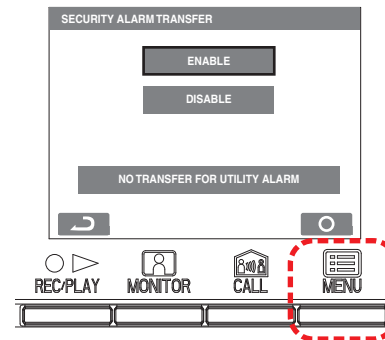

10-5 Doctor call setting

Set Doctor call to be enabled or disabled.

- 1 After performing steps 1 in section 10-1, select "DOCTOR CALL" in the "INSTALLATION" screen and press the [MENU] button.

- 2 Select from "ENABLE/DISABLE" in the "DOCTOR CALL" screen. Press the [MENU] button to complete the settings.

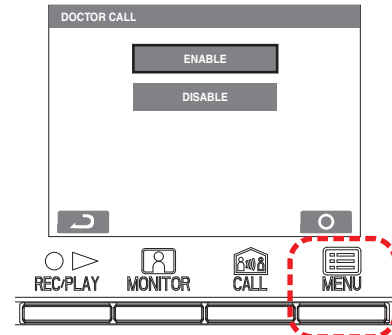

10-6 Press-to-talk setting

Set press-to-talk during communication to be enabled or disabled.

- 1 After performing steps 1 in section 10-1, select "PRESS TO TALK" in the "INSTALLATION" screen and press the [MENU] button.

- 2 Select from "ENABLE/DISABLE" in the "PRESS TO TALK" screen. Press the [MENU] button to complete the settings.

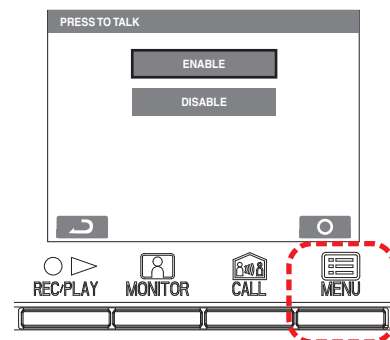

10-7 Call ID display setting

Set to enable or disable the call ID display of the entrance station or guard station when a call is received from either.

- 1 After performing step 1 in section 10-1, select "DISPLAY CALL ID #" in the "INSTALLATION" screen and press the [MENU] button.

- 2 Select from "ENABLE/DISABLE" in the "DISPLAY CALL ID #" screen. Press the [MENU] button to complete the setting.

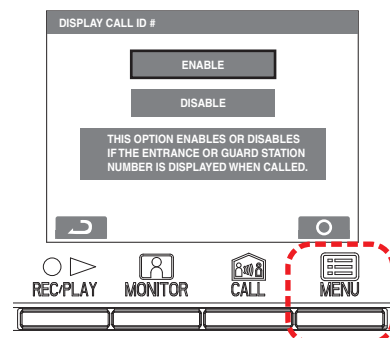

10-8 Initializing

All settings can be restored to their condition at the time of purchase.

NOTES:

- Recorded pictures are erased and settings are reset.
- Pre-set functions are not reset.

Settings reset with "Restore default setting"

Setting name		Description
DATE/TIME		JAN/01/2011 00 : 00
LANGUAGE		ENG FRA DEU ESP NED ITA
ENTRANCE CALL TONE		♪1 • ♪2 • ♪3 • ♪4 • ♪5
DOOR CALL TONE		♪1 • ♪2 • ♪3 • ♪4 • ♪5
GUARD CALL TONE		♪1 • ♪2 • ♪3 • ♪4 • ♪5
DOCTOR CALL		ENABLE DISABLE
PRESS TO TALK		ENABLE DISABLE
DISPLAY CALL ID #		ENABLE DISABLE
PICTURE MEMORY	Pictures	All saved pictures are erased.
	Screen	<ul style="list-style-type: none"> Zoom X 6 Wide X 6 Zoom X 3, Wide X 3 Wide X 3, Zoom X 3
CALL DURATION		30 sec. • 45 sec. • 60 sec. • 90 sec. • 120 sec.
NIGHT ILLUMINATION		ENABLE • DISABLE
ALARM INPUT		DISABLE • N/O • N/C
EXTERNAL INPUT (S1 to S3)		DISABLE • UTILITY • SECURITY
UTILITY-SENSOR	Detection	N/O • N/C
	Alarm timer	10 sec. • 1 min. • 10 min. • 1HOUR • CONT
SECURITY-SENSOR	Detection	N/O • N/C
	Alarm timer	10 sec. • 1 min. • 10 min. • 1HOUR • CONT
	Alarm Transfer	ENABLE • DISABLE
DEPARTURE TIMER SETTING		0 sec. • 30 sec. • 60 sec. • 120 sec. • 300 sec. • 600 sec.
ARRIVAL TIMER SETTING		0 sec. • 30 sec. • 60 sec. • 120 sec. • 300 sec. • 600 sec.
SECURITY PIN		▲ • ► • ▼ • ◀
RESET SETTING		ENABLE • DISABLE
GUARD (GUARD 1 to 4)		GUARD • CONCIERGE • RECEPTION • NOT DISPLAYED

* : Default setting.

- After performing steps 1 in section 10-1, select "INITIALIZE" in the "INSTALLATION" screen and press the [MENU] button.
- Press the [MENU] button in the "INITIALIZE" screen to perform initialization. Press the [REC/PLAY] button to cancel initialization and return to the previous screen.

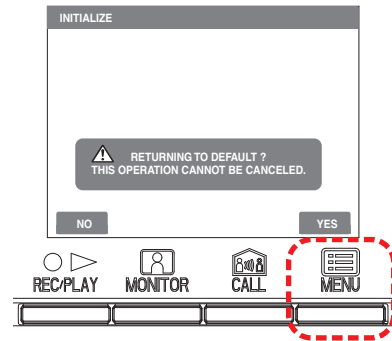

- The status LED and tone off LED light up during initialization. The screen goes out when initialization is complete. (The status LED flashes.)



Issue Date: Jun. 2017

Ⓐ 0617 AZ 59045

AIPHONE CO., LTD., NAGOYA, JAPAN